

# VR Legend Console

User Manual

527-136  
Issue 3

---

© 1999 AMS Neve plc own the copyright of all information and drawings contained in this manual which are not to be copied or reproduced by any means or disclosed in part or whole to any third party without written permission.

---

As part of our policy of continual product improvement, we reserve the right to alter specifications without notice.

---

Disclaimer: The information in this manual has been carefully checked and is believed to be accurate at the time of publication. However, no responsibility is taken by us for inaccuracies, errors or omissions nor is any liability assumed for any loss or damage resulting either directly or indirectly from use of the information contained within it.

---

## HEAD OFFICE

AMS NEVE PLC • BILLINGTON ROAD • BURNLEY  
LANCS BB11 5UB • ENGLAND  
TELEPHONE: +44 (0) 1282 457011 • FAX: +44 (0) 1282 417282

## LONDON OFFICE

TELEPHONE: +44 (0) 171 916 2828 • FAX: +44 (0) 171 916 2827

## NORTH AMERICAN OFFICES

AMS NEVE INC., NEW YORK  
TEL: +1 (212) 965 1400 • FAX: +1 (212) 965 3739  
AMS NEVE INC., HOLLYWOOD  
TEL: +1 (818) 753 8789 • FAX: +1 (818) 623 4839  
RUPERT NEVE CANADA INC., TORONTO  
TEL: +1 (416) 365 3363 • FAX: +1 (416) 365 1044  
e-mail: [enquiry@ams-neve.com](mailto:enquiry@ams-neve.com)  
<http://www.ams-neve.com>

# CONTENTS

---

## GLOSSARY

Terms Used In This Manual	1:1
---------------------------	-----

## INTRODUCTION

System Information	2:1
--------------------	-----

## THE VRL CONSOLE SURFACE

The VRL Channel Strip	3:2
Channel Faders	3:8
Global Master Fader Controls	3:9
Meter Bridge	3:10
Monitor and Facilities	3:12

## ROUTING

48-track Routing	4:1
2-track Routing	4:1
Input Section	4:3
Auxiliary Section	4:4
Direct Routing	4:6
Signal level of the multitrack send	4:6
Reverse master status for record and mixdown modes on a local basis	4:7
Swap small and large faders	4:8
Monitor path assignment	4:9
Solo and Master Cut System	4:10
Mix Outputs	4:15
Effects Return	4:16

## **MONITORING**

Oscillator and Signal	5:1
Auxiliary Master Section	5:2
Cue Mix System	5:3
Rev Returns	5:5
Master Status Selection	5:6
Multitrack Monitoring and Overdubbing	5:8
Cue Sends	5:8
Control Room Monitor	5:9
Monitor Selection	5:10
Studio Monitor	5:11
Talkback System	5:12

## **METERING**

Multitrack Meters	6:1
Control Room Monitor Metering	6:4
Output Metering	6:5
Aux Meters	6:6
Phase Meter	6:7

## **PROCESSING (DYNAMICS and EQ)**

Channel Processing	7:1
Cue Mix and Rev Return	7:1
Input Filter	7:2
Gate/Expander	7:3
Limiter/Compressor	7:5
Insertion	7:7
Equaliser	7:8
Sidechain Equalising	7:10

## **FADER DIRECT INPUT MODULE (Optional)**

Facilities	8:1
Using the Fader Direct Input Module	8:2

**VSP (Optional)**

Facilities	9:1
Panel ON	9:2
4, 8, Film Bus Modes	9:2
Mix Bus Signal Flow	9:3
MATRIX and Speaker Busses	9:4
Metering	9:5
Playback Control	9:6
Options	9:6
Inserts & Filters	9:7
Dialog	9:8
Alternate Monitor	9:8
Monitor Speaker Set	9:9
Studio Loudspeakers	9:10
2 Track Control	9:11
MONO Input/Output Routing	9:14
Group Insert Selection	9:15
Monitor Cut and Solo	9:15
Linked Controls and Switches	9:16
Oscillator Override	9:17
Diagnostics Mode	9:18
Software Hard Reset	9:18

**RECALL**

Glossary	10:1
Introduction	10:7
Installation	10:7
The Keyboard	10:8
Key Functions	10:9
Key Functions continued	10:10
Screens	10:11
Hidden Access Commands	10:11
Disk Commands	10:12
Diagnostics	10:14
Set-up Procedure	10:14

**GUIDED TOUR OF RECALL**

Introduction	10:15
Getting Started	10:16
Top Level Menu	10:16
Open Store List	10:19

**INDEX**

## GLOSSARY

### Terms Used In This Manual

#### AFL (After Fade Listen)

Allows users to monitor specific signals after the fader, without affecting the main outputs. An AFL bus sums all the AFL'd signals and is routed to monitoring. Sometimes AFL is a stereo bus to allow monitoring of individual channels in their stereo panned positions.

AFL is accessed on channel modules.

#### Attenuation

The reduction in level of a signal.

#### Audio grouping

A single audio output which is a sum of all the channels in the group.

A single fader controls the level of the summed signals.

There is a group output from the console which is effectively a mix of the audio signals in that group.

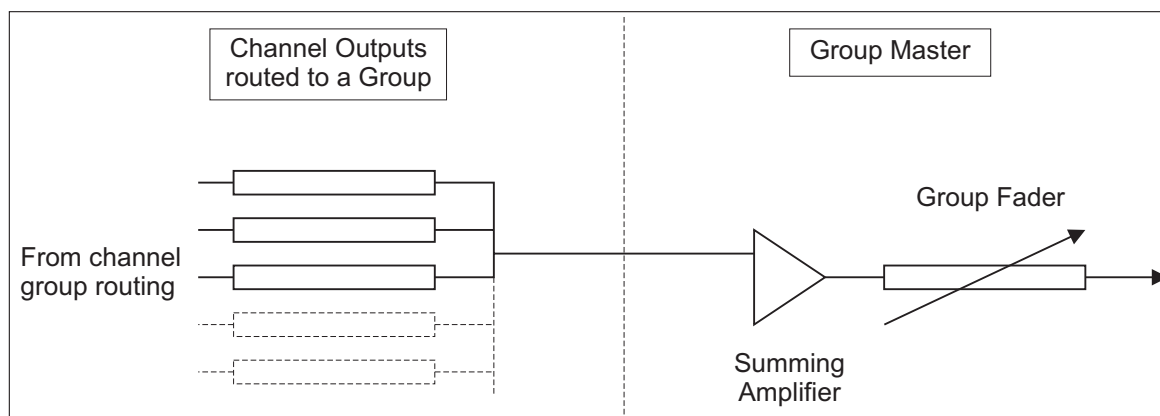

See also CONTROL GROUPING.

#### Aux

An auxiliary output from (or sometimes input to) the console, often an effects send.

There are individual aux send level controls on channels as well as master controls for the entire console.

#### Bell

Used to describe a 'peaking' equaliser rather than a shelving one.

The term is derived from the shape of the filter curve, rather than the sound of the effect.

**Bounce**

Allows the monitor signal of a particular channel to be routed back to the track assignment buses for 'bouncing down', where a number of previously recorded signals are re-recorded onto different tracks usually with some mixing.

**Bus**

A 'Summing point' for all signals routed to the same place.

A bus will usually be either a balanced or unbalanced line running most of the length of the console carrying a signal for a particular destination (e.g. 'stereo mix bus' picks up all signals routed from channels to the stereo mix).

Sometimes used to describe a channel module facility.

**Channel**

Traditionally used to describe a particular input path on the mixing console.

Sometimes used to describe the path from microphone to multitrack tape (where 'monitor' designates the return from multitrack to mix on an in-line console).

**Clipping**

An effect created when the electrical level of an audio signal at some point in the chain exceeds the overload level of the stage in question, resulting in squaring off from the waveform and distortion.

**Comms**

Abbreviation of 'communications' (the talkback between artists and control room).

**Control grouping**

The levels of faders in a group are controlled from one fader (each maintaining its level in relation to the others), but their outputs remain separate - (i.e. unlike audio grouping it does not involve a single summed audio output for the group).

See also AUDIO GROUPING.

**Control room monitor**

Used to adjust the level of the control room loudspeakers independent of the level mix.

**Cue**

An output from the console which carries a mix of signals to artists for monitoring on headphones.

Normally made up of individual signals sent from the channel aux buses.

A cue can be stereo or mono.

**Cut**

A switch to mute the relevant signal from its destination (e.g. the CUT switch on the monitor fader cuts that channel from the mix).

Also known as mute.

**Dump**

A facility for dumping the stereo mix of a channel to the multitrack assignment matrix.

**Echo return effects send**

Another name for aux send (usually used for effects).

**EQ**

Abbreviation for EQUALISATION (a means of controlling the frequency characteristics of a signal across the audio spectrum).

**Fader**

A sliding gain control with full attenuation at the bottom of its travel, a unity gain position near the top and usually some 10dB of gain above unity (in the case of channel/monitor faders).

**Filters**

Used to cut the high or low end of the frequency spectrum at certain points in the signal chain.

**Foldback**

Outputs from the console which return cues to artists (similar to CUES).

**Gain**

The amount of amplification provided by any stage in the signal chain (negative gain is ATTENUATION).

**HPF (high pass filter)**

Allows the passage of signal content which is above the filter frequency.

**Input module**

A physical module which carries an input from an external source and routes it to other destinations on the console.

Also provides some facilities for modifying the sound.

**Jackfield**

A collection of sockets carrying signals from various points in the signal chain to allow 'patching' of signals from location to location.

**Limiter**

Used to limit the level of a signal to a particular point.

This can either be for an effect or to prevent overload elsewhere in the system.

**Link**

Allows users to operate simultaneously on stereo pairs with no image shift occurring if there are level discrepancies between channels.

Links the dynamics control signal between adjacent channels.

**LPF (low pass filter)**

Allows the passage of signal content which is below the filter frequency.

**Module**

A piece of removable hardware in the control surface of the console (e.g. 'master module' or 'input module').

**Normalling**

The process by which jacks are connected together so that a signal flows between two rows when no insertion is made.

**Null LEDs**

VCA faders are provided with null LEDs which point in the direction that the fader must be moved to make its position correspond to the gain of the VCA.

**Oscillator**

Produces tones at various frequencies for lining up the system.

It can be routed to a number of outputs on the console.

**Pan**

Used to move a signal to a point somewhere between left and right in the stereo mix image.

This is achieved by splitting the single signal from the monitor fade into two signals (left and right).

**Parametric EQ**

Equalisation which is fully and continuously variable in frequency, Q, and level.

**PFL (Pre-fade listen)**

Monitors specific signals before the fader without affecting the main mix outputs. PFL is always in mono.

**Phantom power**

Most professional mics require 48 volts phantom powering (supplied through the mic cable). There is a switch on the input module to switch it on or off.

**Post**

Usually refers to a signal take-off point such as an aux send.

After the fader.

**Pre**

Usually refers to a signal take-off point such as an aux send.

Before the fader.

**Q**

The Q of a filter is defined as its centre frequency divided by bandwidth (the distance between frequencies where the response is 3dB down on the peak). This affects the 'sharpness' of the filter peak or notch.

High Q gives the sharpest response and is used to boost or cut one specific region.

Low Q gives a very broad response and is used when boost or cut over a relatively wide range of frequencies is required.

**Return**

Additional input to the console.

Usually used for returning effects to the mix.

**Reverse**

Refers to the swapping of the large and small faders.

**Send**

An output from the console (see AUX, CUE, ECHO SEND).

**Slate**

Allows the output of a microphone to be recorded onto tape (sometimes along with a Low Frequency tone to identify takes).

The LF tone can be heard when winding tape at high speed.

**Solo**

Allows users to hear an isolated sound and treat it individually (i.e. without hearing the rest of the mix).

Often used when applying effects and EQ.

Because there are times when nothing can be heard from the loudspeakers (due to a SOLO button being down with no signal on that track) a light is provided to show that SOLO mode is selected.

## Subgroup

Channel signals can be made more manageable by grouping faders together, this group of faders is known as a sub-group.

The sub-group is routed to the stereo mix or can be panned between two subgroups and then to the main mix via a single level control (i.e. the subgroup fader).

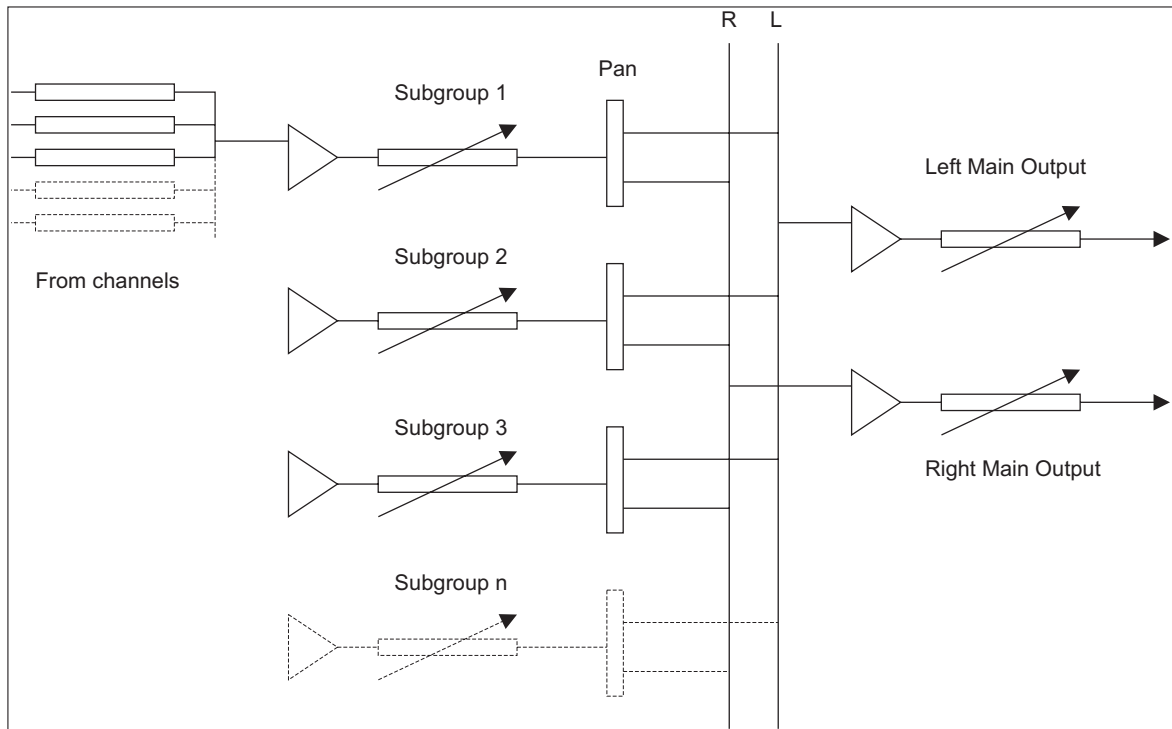

## Talkback

The talkback between artists and control room.

## Tape

Selects the multitrack tape as the input to the monitor (as opposed to the line output of the console).

## Trim

Used for trimming the overall level of the send to multitrack for a particular bus.

Normally trims the level sent to the track (which corresponds to the number of the module).

## Width

A stereo width control used to widen or narrow the image of a stereo pair.

## INTRODUCTION

---

### System Information

The VRL is an 'in-line' monitor type console.

Each channel strip contains all the facilities necessary for multitrack recording, overdubbing and mixdown.

Two distinct signal paths are processed by each module.

The channel signal path handles input sources during recording and tape playback during mixdown.

The monitor path is used primarily for monitoring multitrack sends and playback and for effects sends or returns during mixdown.

The monitoring path can also provide additional tape replay inputs for very large mixdown operations.

Versatile switching enables the various I/O module sections to be configured between the two paths, allowing the operator to arrange each path to give the simplest and most efficient control.

Input selection and output routing for the I/O module paths are determined by the console master status controls.

The controls offer the unique feature of split console operation - i.e. the console can be operationally divided into two halves (to the left and right of the master control panel).

Configuring the console in this way offers many useful facilities, including the capability of using each half of the desk for separate monitor operations.

The resulting signal path flexibility allows the operator to concentrate on the creative aspects of the session rather than the technical limitations imposed by a restrictive system.

## Multitrack Recording

Input mic or line signals are fed via the channel path and large fader to the multitrack routing matrix.

The inputs can be processed using the high and low pass filters, equaliser and dynamics units.

The channel path can be routed directly to the track send of the same number or designated as part of an audio subgroup; the latter allows overall dynamic, equalisation and level processing to be achieved on a mix of inputs before the signals are recorded on tape.

The track level control provides simple level adjustment for the track send.

Simultaneous monitoring of either the multitrack sends or returns is possible with switching performed on a master basis, controlled from the monitor section.

The equaliser and dynamics can be configured in the monitor path from the switch matrix next to the small fader on the I/O module, and in a similar way the auxiliaries may be configured in the monitor path, prefade, precut for cue sends to the studio and postfade for monitor reverb sends.

The small fader is usually configured for monitoring but this can be reversed at the I/O module or on a master basis from the monitor section.

The monitor signal can then be panned and routed via the 4-track routing matrix to one of the two stereo main outputs.

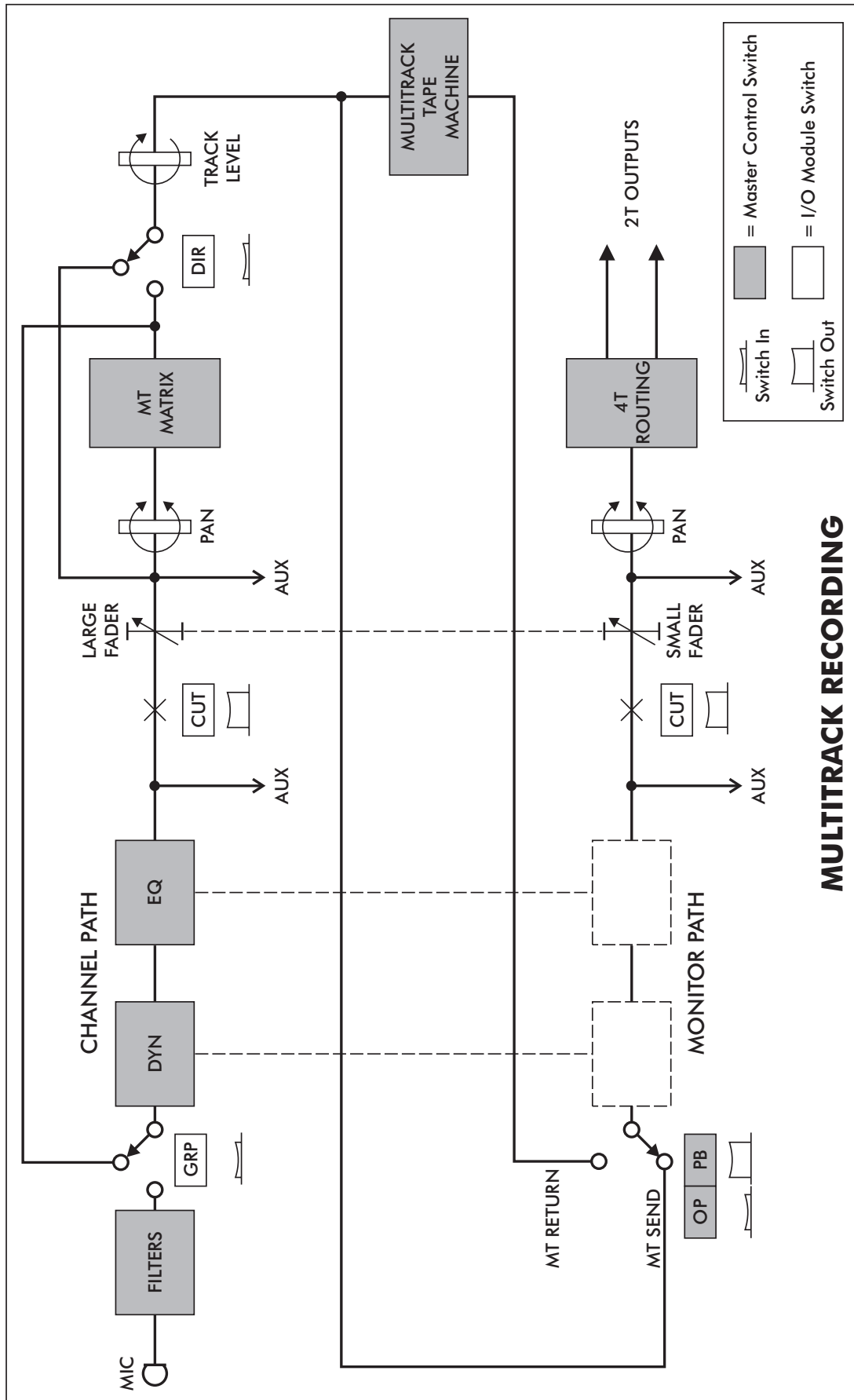

## Mixdown

In mixdown the configuration of the I/O module is effectively the opposite of the multitrack recording situation.

The channel path feeds the 4-track routing matrix via the large fader and accepts primary multitrack return mix inputs with full in-path processing and auxiliary sends.

The monitor path has the following three distinct purposes.

- 1) It accepts secondary mix inputs and makes available unused channel path processing. Access to the 2-track main outputs is provided on the multitrack routing matrix.
- 2) In a similar way effects returns can be accepted by the monitor path.
- 3) The path can be used for channel post-fade effects sends.

The monitor path fader controls the send level to any one of the 48 groups available from the multitrack routing matrix.

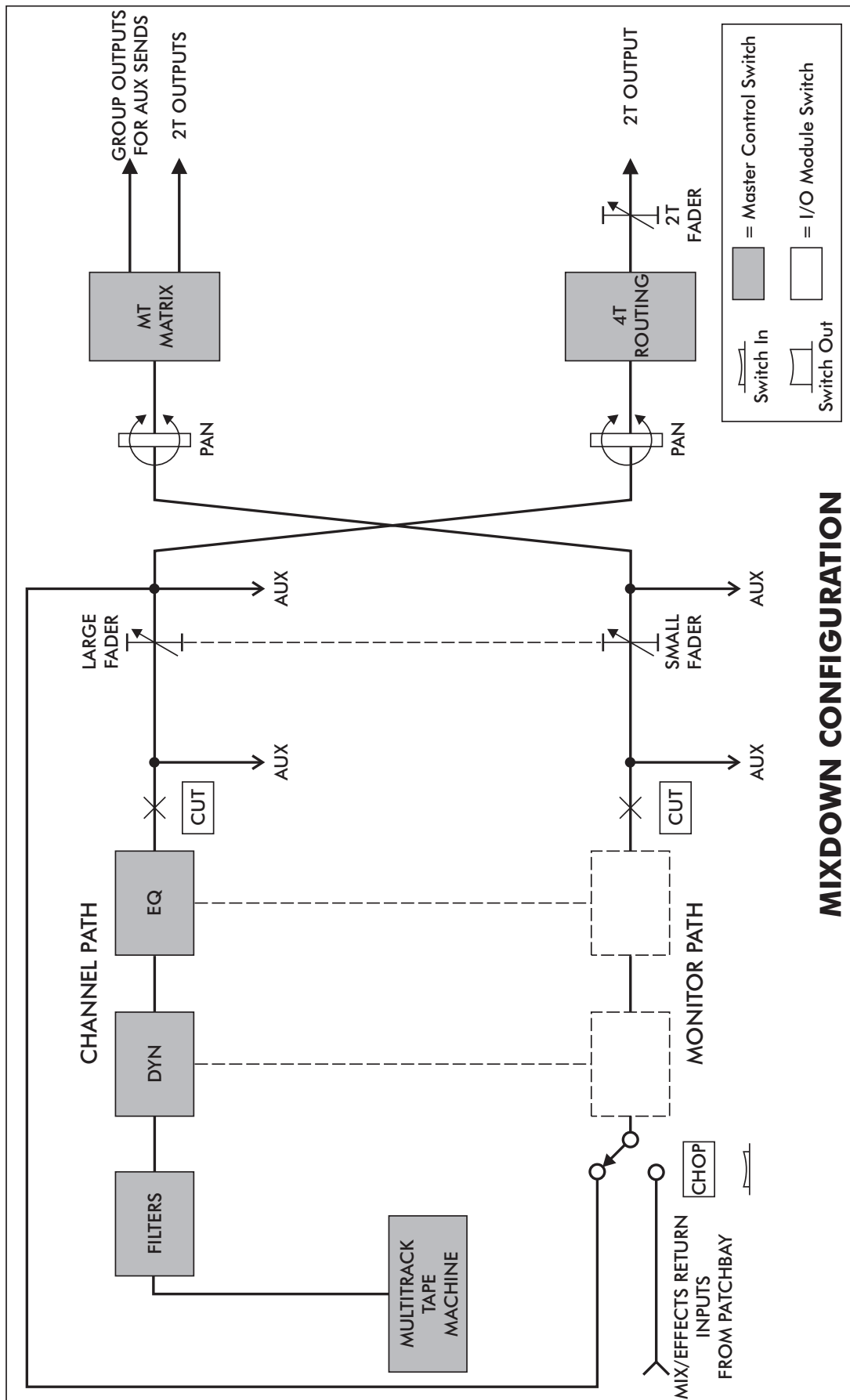

## Track Bouncing

Patch free track bouncing can be easily achieved on the console.

The I/O module is configured so that the multitrack return feeds the monitor path, but is then routed back to the multitrack routing matrix.

By simply selecting the bounce facility and making a routing selection on each track return to be bounced, the whole operation can be quickly achieved.

Equalisation and dynamics can be configured in the monitor path to allow processing while bouncing.

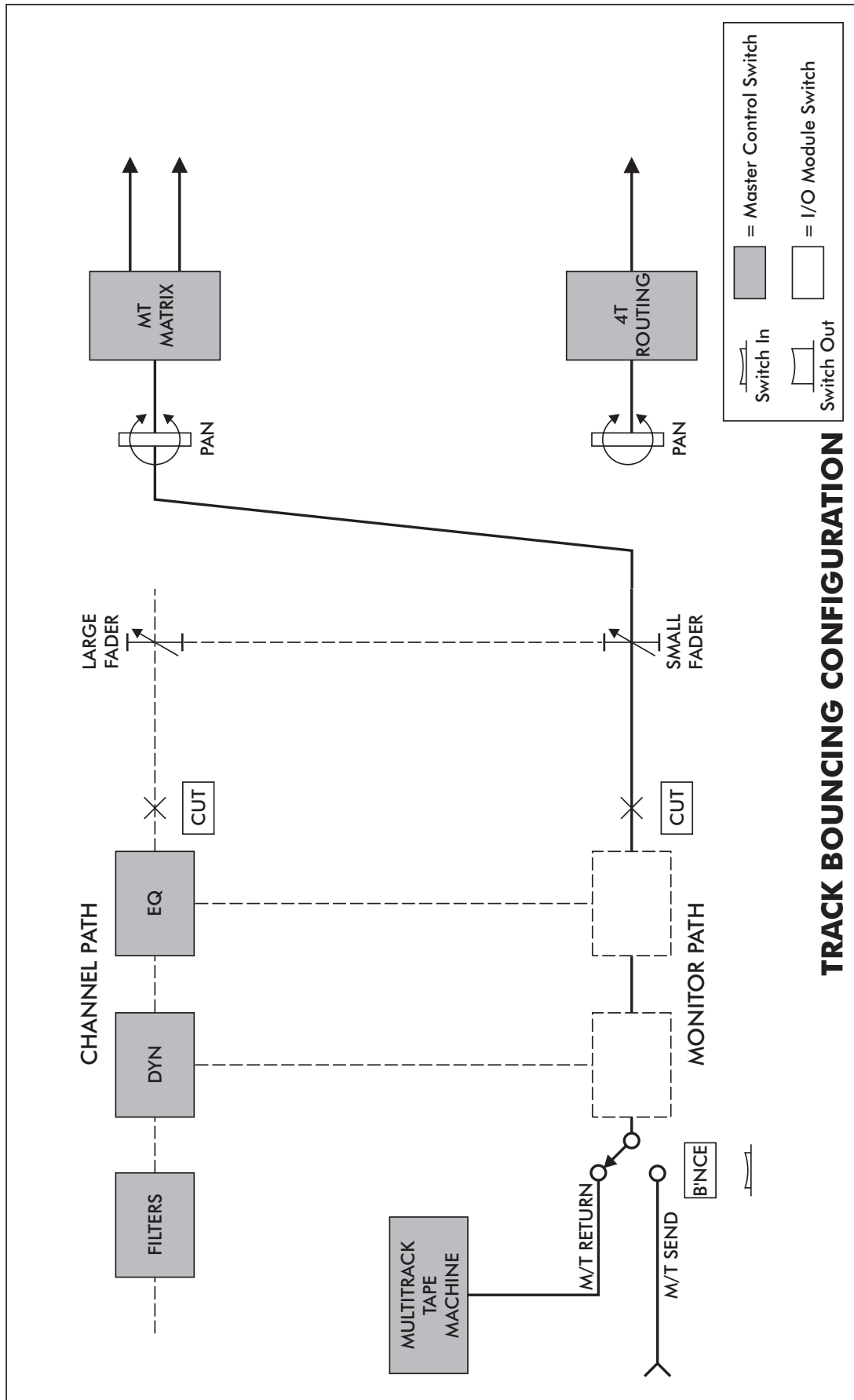

## Overdubbing

Provides users with a flexible overdubbing facility.

The master overdub pushbutton is shown as master O/D.

The individual channel overdub pushbutton is shown as channel OD.

The console has a sophisticated monitoring and cue send system for tracklaying and overdubbing which allows the engineer total monitoring freedom in the control room whilst maintaining the correct cue sends to the studio.

The system works with interactive controls which cover the various monitoring requirements.

Five master controls operate the system with additional channel OD pushbuttons on each I/O module.

Master monitor status is controlled by three interlocking Multitrack Monitor pushbuttons O/P, P/B and master O/D and the CUES pushbuttons MIXED CUE and CUES POST EQ.

The Multitrack Monitor pushbuttons switch control room monitoring on a master basis from multitrack send OP, to multitrack return PB, and overdub master O/D where multitrack send is selected on individual (channel OD) switched tracks and multitrack return is selected on the backing tracks. The individual channel OD pushbuttons affect cues being sent to the studio as well as switching control room monitoring in the master (master OD) monitoring mode.

The multitrack send of any module switched into channel OD is applied to the cues.

The backing track cues (not channel OD selected) receive multitrack return.

The cue sends on channel OD tracks can also be switched to MIXED CUE, a mix of multitrack send and return, which can be varied on an individual basis with a trimmer on each I/O module.

The backing track cues can be assigned to a 'follow monitor' condition using CUES POST EQ, when any monitor equalisation and dynamics are also heard on the cues.

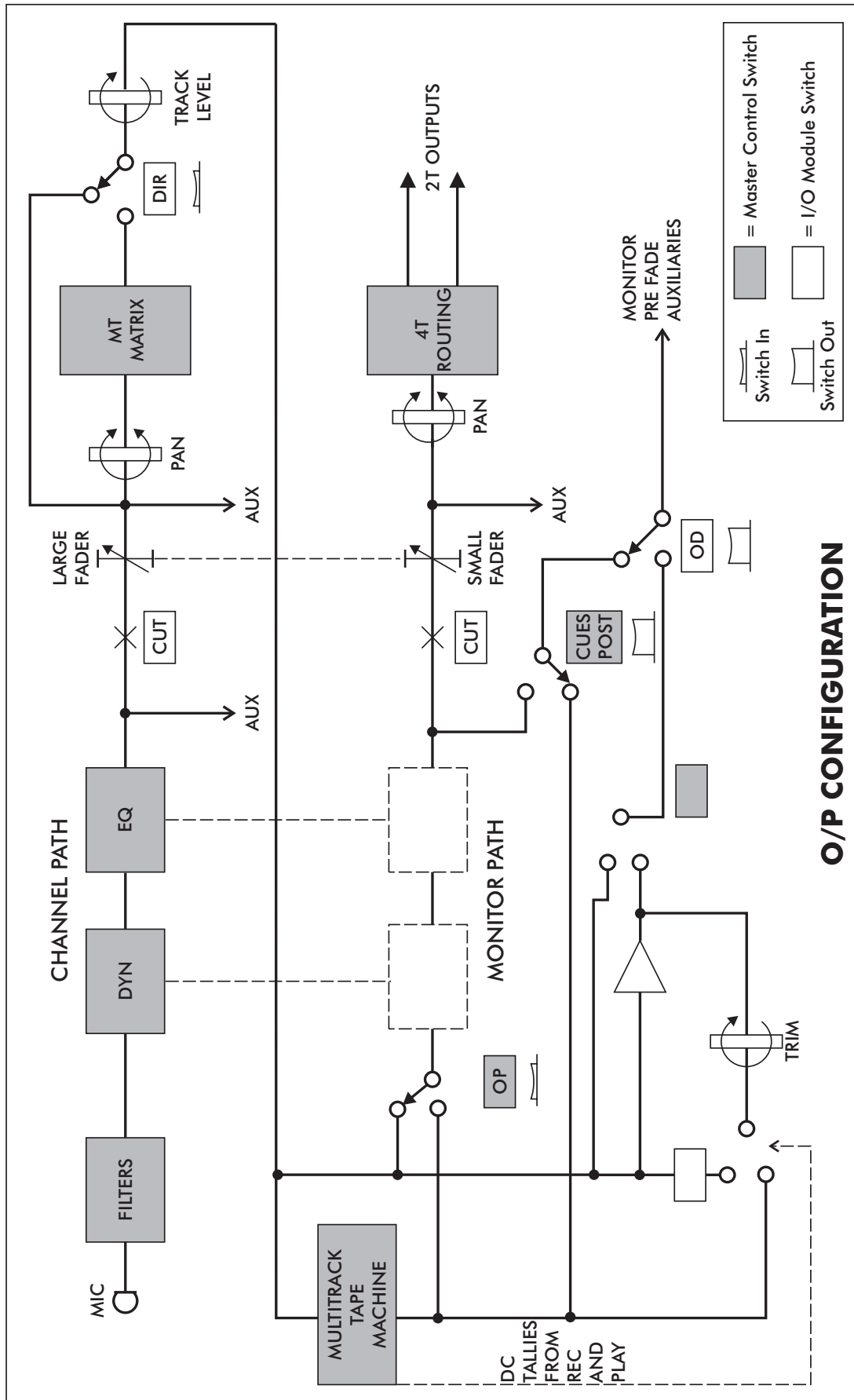

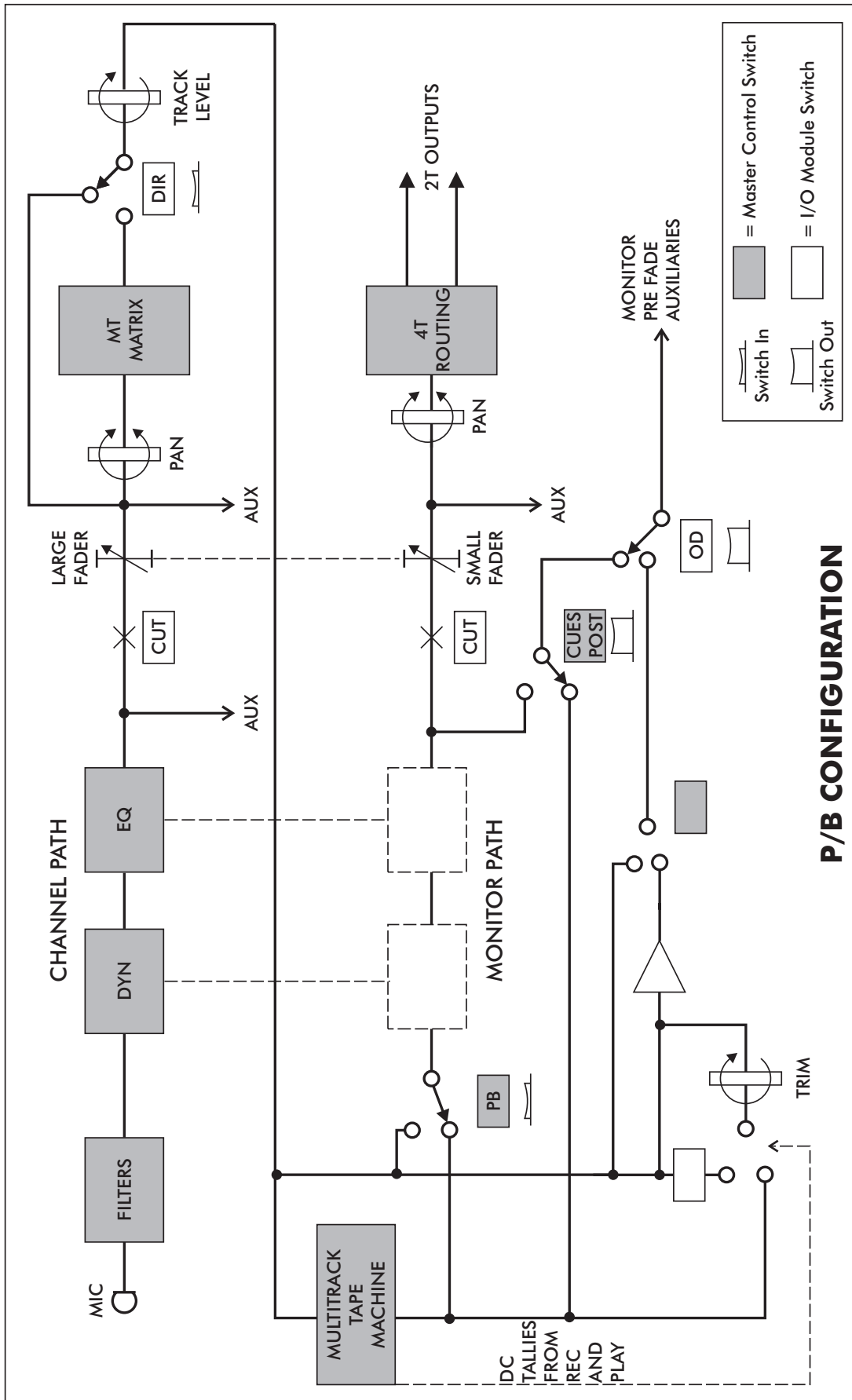

**P/B CONFIGURATION**

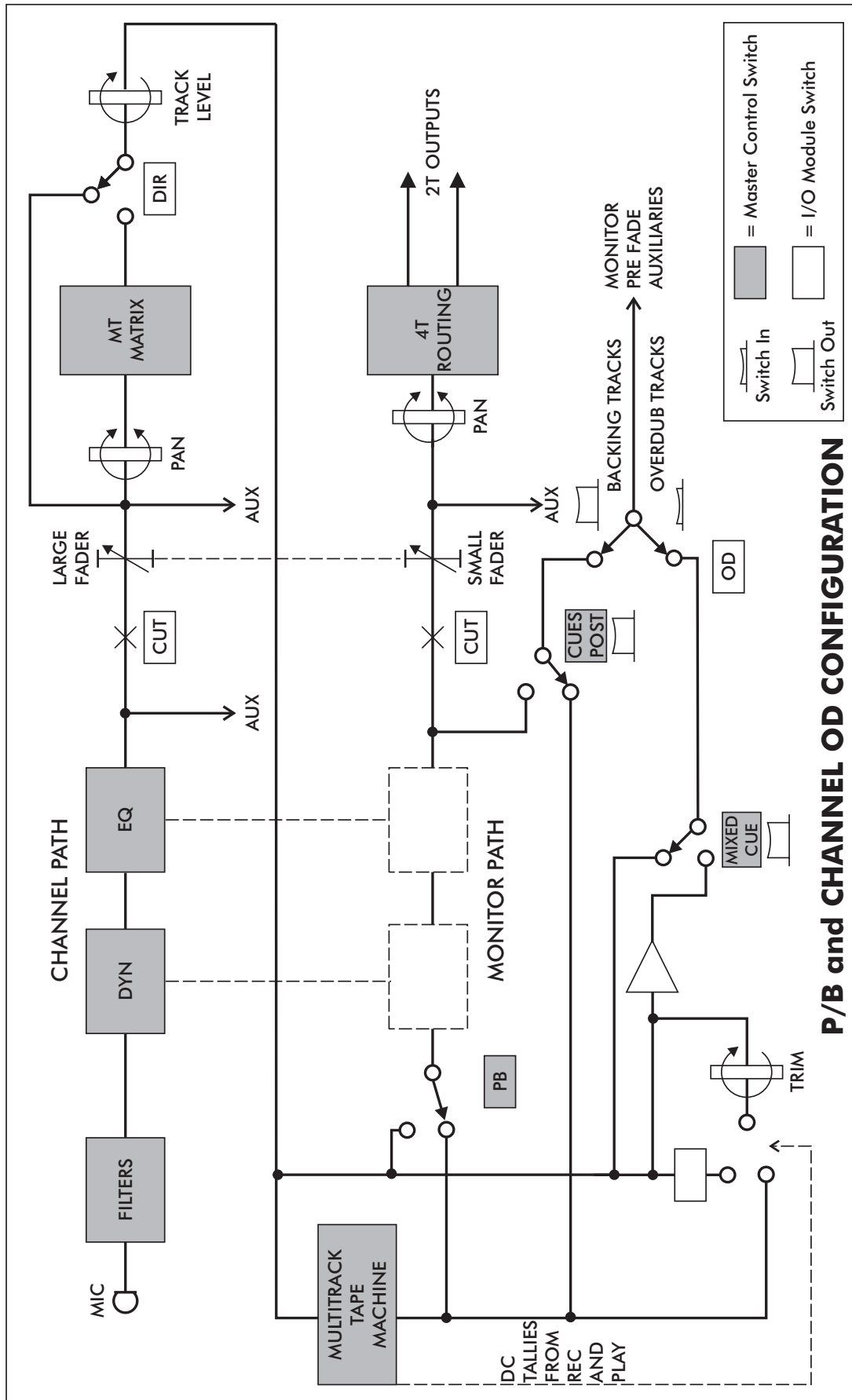

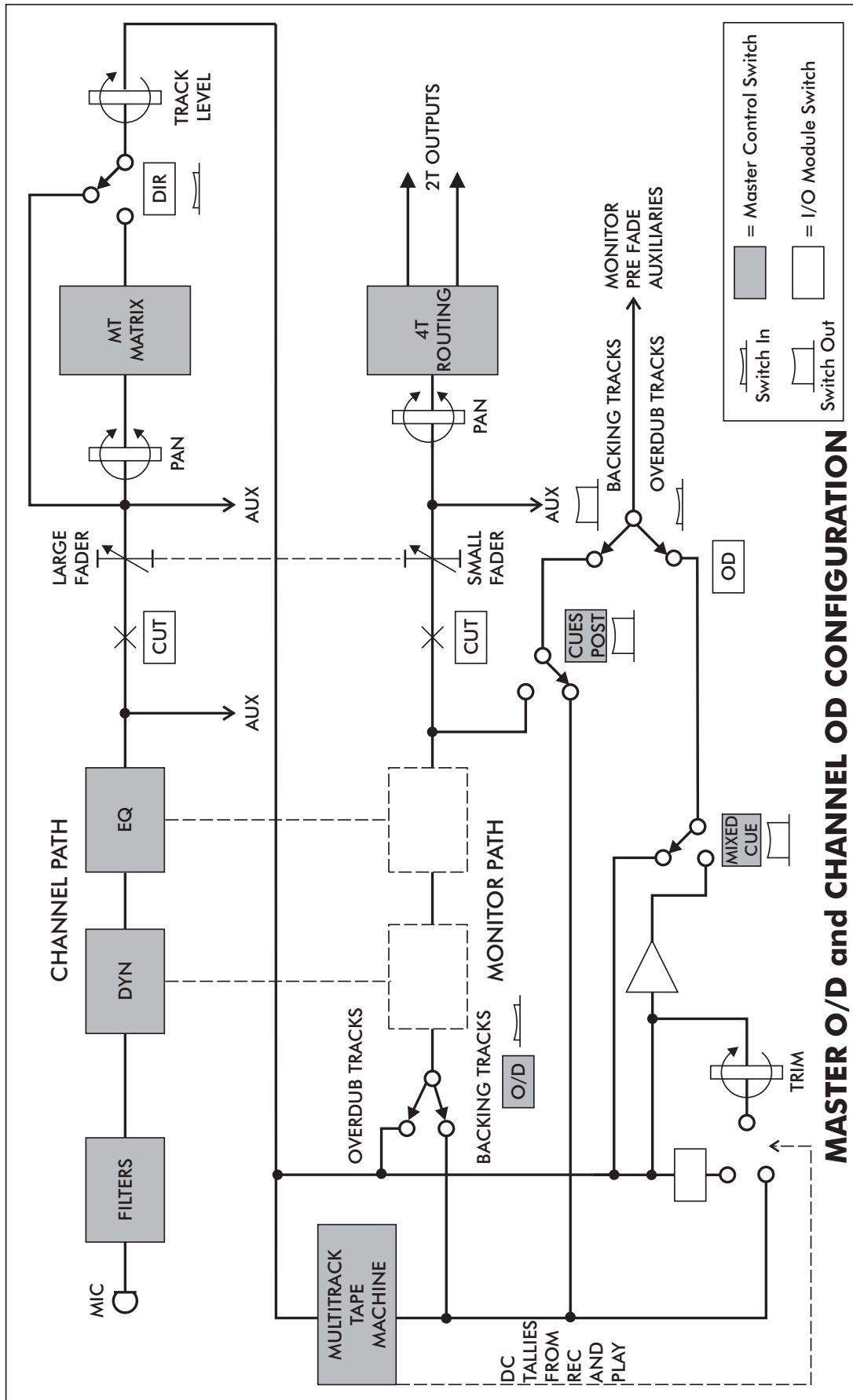

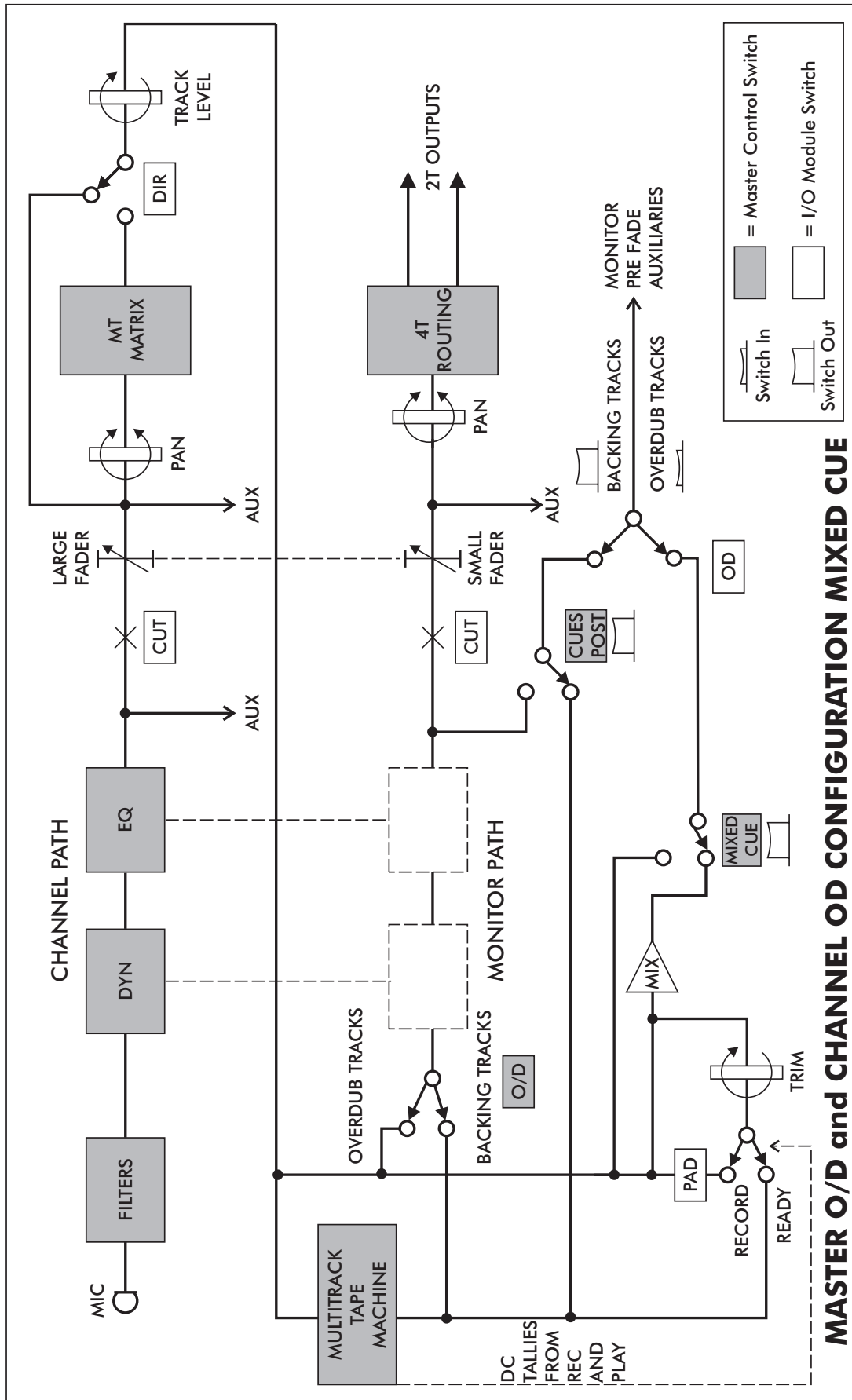

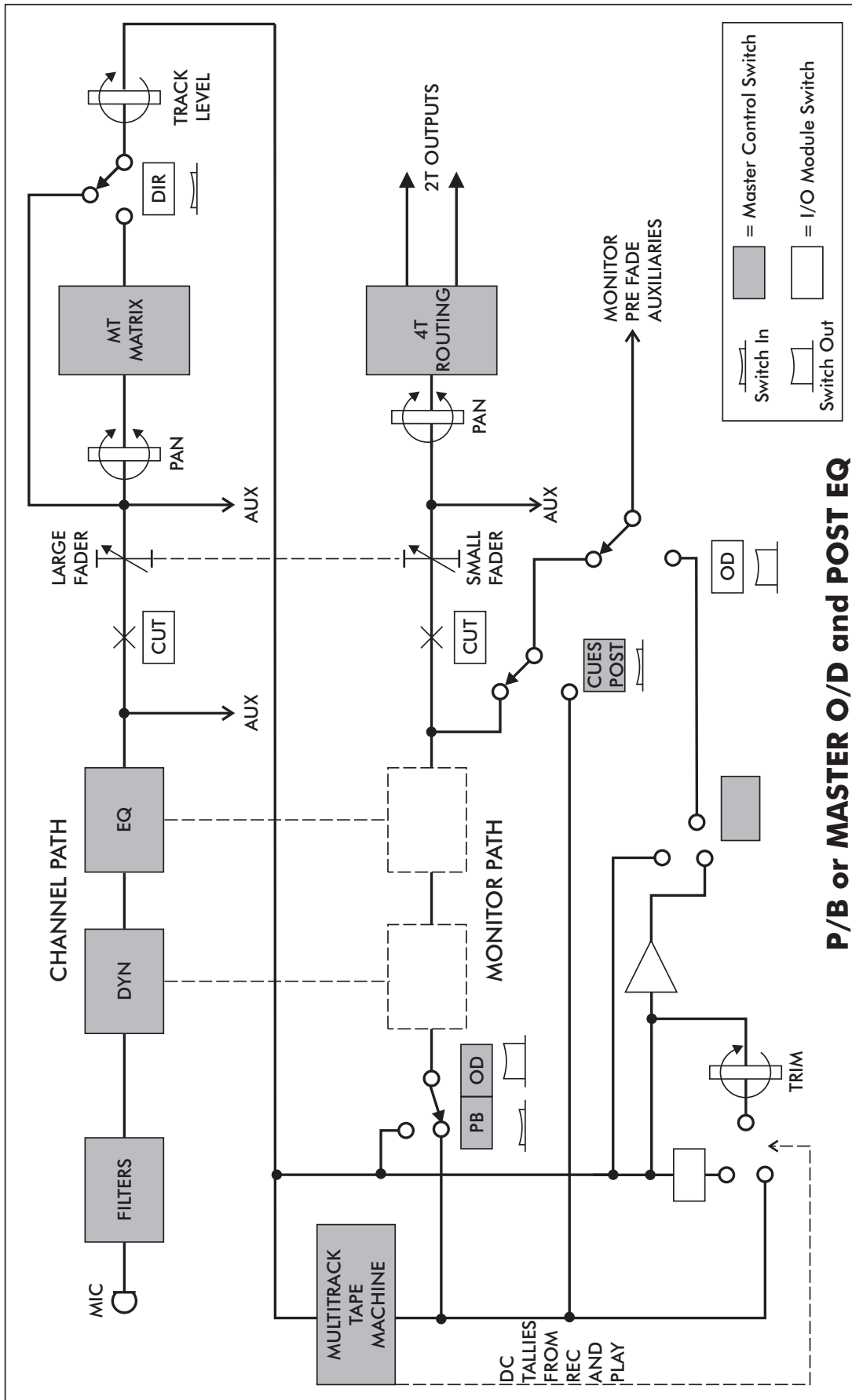



**Broadcast Mode**

This mode allows simultaneous broadcast and multitrack recording.

When BROADCAST is pressed the signal is taken prefade, post-equalisation and applied to the input of the secondary path.

Fader swap is automatically engaged when BROADCAST is selected and can be cancelled whilst broadcast is still engaged.

This facility allows the small fader to control the multitrack mix and the large fader to control the broadcast signal.

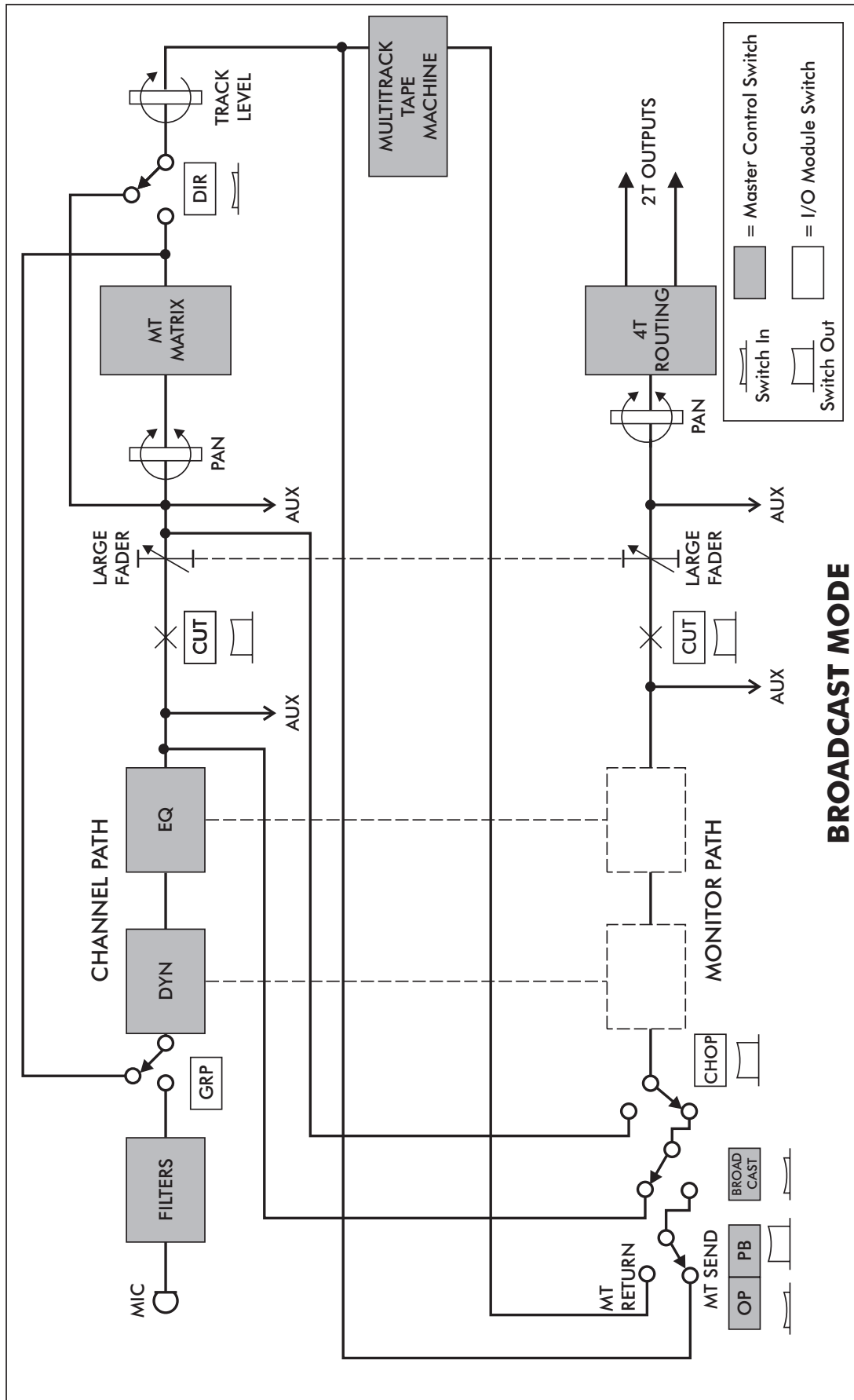



## THE VRL CONSOLE SURFACE

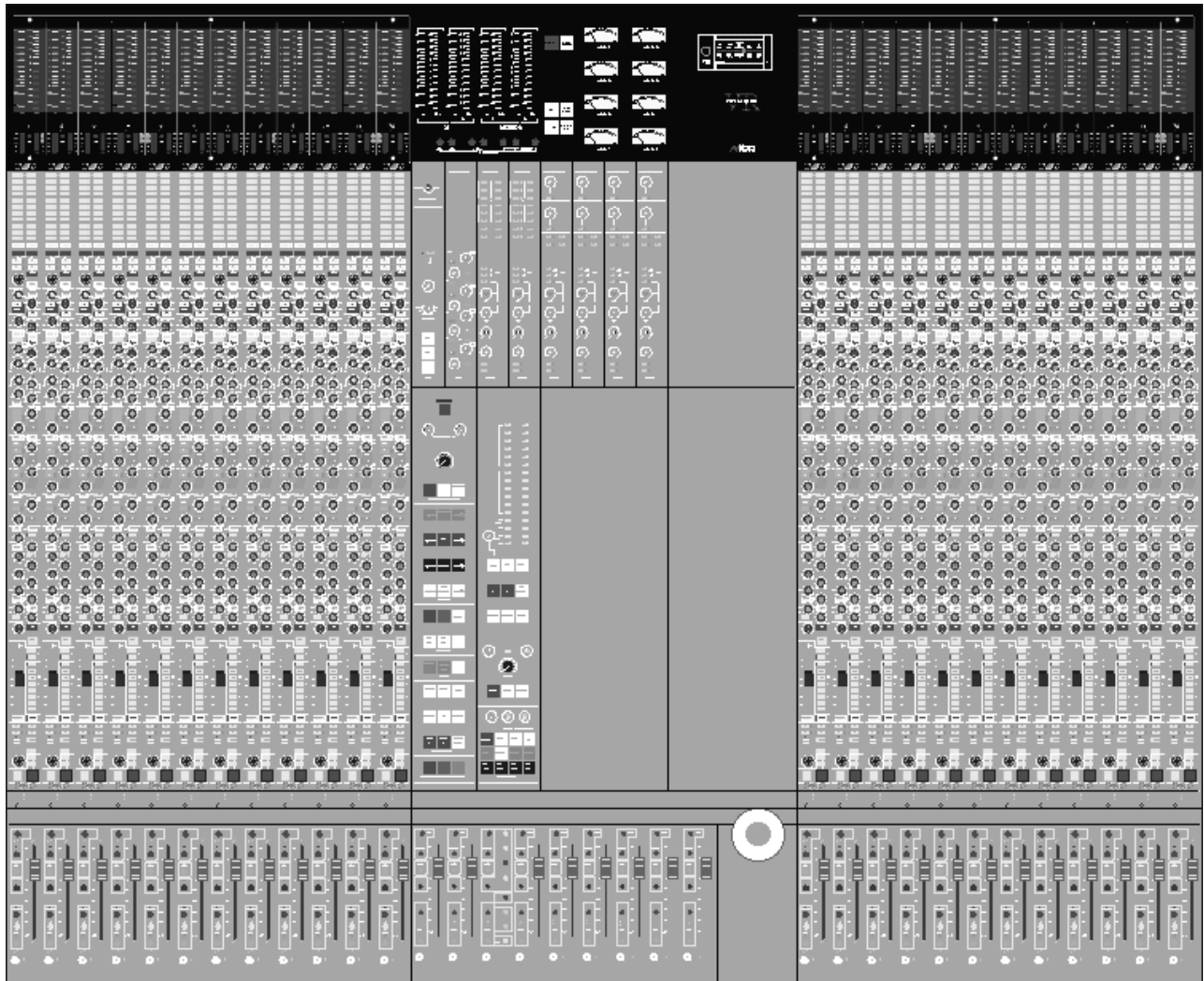

24 Fader VRL Console

## The VRL Channel Strip

### Multitrack Routing Matrix

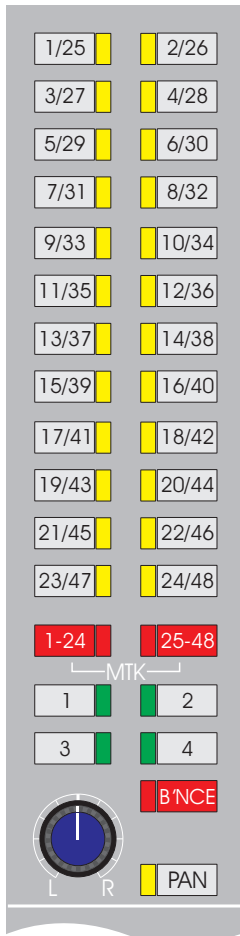

Channel Strip  
Multitrack Routing  
Module

The routing matrix offers 48-track routing with selection of any or all of buses 1-24 or 25-48 from each channel.

Panning is selectable between odd and even track sends.

Access is provided to the main outputs to facilitate extra mix inputs and effects returns through the monitor path during mixdown.

Track bouncing is easily achieved, sending the relevant multitrack return back to the routing matrix via the monitor path.

Routing to the 2-track outputs is automatically cancelled to prevent doubling of the monitoring signal level.

The bounce signal can be processed by placing the equalisation and dynamics units in the monitor path.

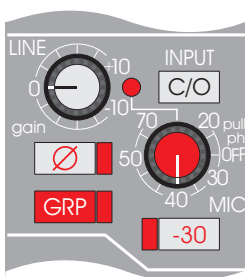

Channel Strip  
Input Module

### Inputs

The mic amp design offers low noise and low distortion at all signal levels.

The gains of the mic and line inputs are adjusted on two continuously variable rotary controls providing a total range of -10dB to +70dB (in conjunction with -30dB PAD) for mic and -10 to +10dB for line with centre detent.

Both inputs can also be phase reversed.

Phantom power can be selected on/off on individual channels.

Patch free audio subgrouping is available as the highest priority input, allowing a group output signal to be processed as a channel signal before being re-routed.

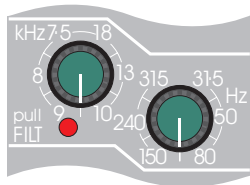

Channel Strip  
Input Filter Module

### Input Filters

These are 12dB/octave high and low pass filters, with frequency ranges from 31.5Hz to 315Hz and 7.5kHz to 18kHz respectively.

The filters can be switched into the channel path independently.

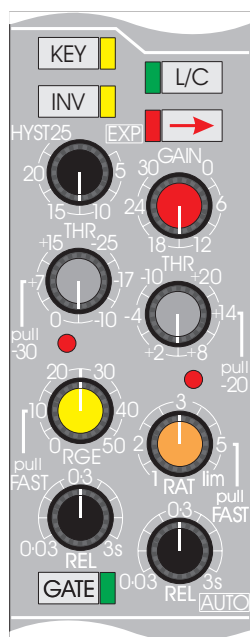

Channel Strip  
Dynamics Module

### Dynamic Control

Full limiter/compressor and gate/expander facilities are available with a fully flexible sidechain (each of which can be individually switched in or out of circuit).

The gate/expander has rotary controls for a 50dB gate range, a 70dB threshold range, release from 30ms to 3s, switchable attack time and variable hysteresis.

Hysteresis makes the threshold level different for signals which are rising or falling in level and allows precise triggering on the wanted signal while still allowing the correct amount of signal 'tail' through.

The expander has a 2:1 expansion ratio.

Switched controls are provided for an external key input and invert (for ducking). The external key input is accessed from the patchbay.

The limiter/compressor has rotary controls for release times from 30ms to 3s with an end stop, a 50dB threshold range, a ratio of 1:1 to limiting and up to 30dB of gain make-up.

Attack time is program dependent with a switch for fast impulse response.

The Release control incorporates a switch for automatic programme dependent release.

'Anti pumping and breathing' circuitry allows the unit to operate on the source musically whilst retaining absolute control over the dynamic range.

The equaliser module can be inserted into the sidechain of the dynamics module for de-essing, etc.

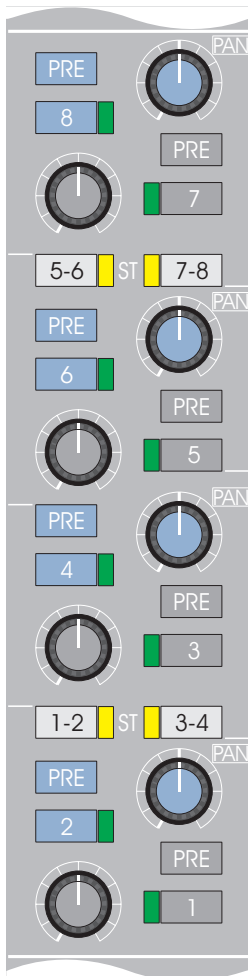

Channel Strip  
AUX Module

## Auxiliaries

The eight auxiliary sends can be configured as eight mono sends with either the channel or monitor path as the signal source.

Each pair of sends can be switched to operate as a stereo aux with level and pan controls.

Each aux send has its own individual On/Off switch and Pre-fade/Post-fade switch.

Operationally, the pre-auxiliaries send signals to the artists in the studio in tracklaying mode and some effects sends in mixdown.

The resource point for the two functions is arranged so that in tracklaying mode the signal is taken pre-cut to enable cut solos to be performed in the control room and still retain cue sends. In Mixdown mode the signal is taken post-cut so that the effects send is cut with the source.

In Mixdown mode the multitrack recorder is routed to the stereo buses via the large fader.

The secondary (monitor) signal path in the channel module is routed to the multitrack routing matrix - allowing as many as 48 fully mixable extra auxiliary sends.

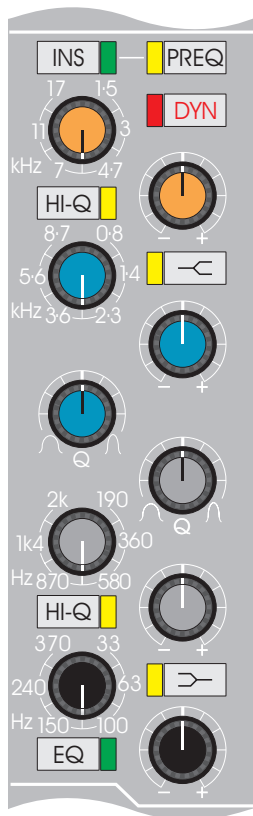

*Channel Strip  
Equalisation Module*

## Inserts

Inserts can be positioned in either the channel or monitor path independently of the equaliser.

Pre-equaliser and pre-dynamics configuration is also possible.

## Formant Spectrum Equalisers

The unique sound of AMS Neve equalisers is the result of years of research and extensive studio experience.

The equaliser provides 4-band parametric equalisation, with overlapping frequency ranges.

The two mid-bands have variable controls for Q (from 0.5 to 9), gain (18dB cut and boost) and frequency.

The high and low frequency controls provide variable gain (18dB cut and boost) and frequency controls with switchable Q (either 0.71 to 2) and peaking/shelving characteristic.

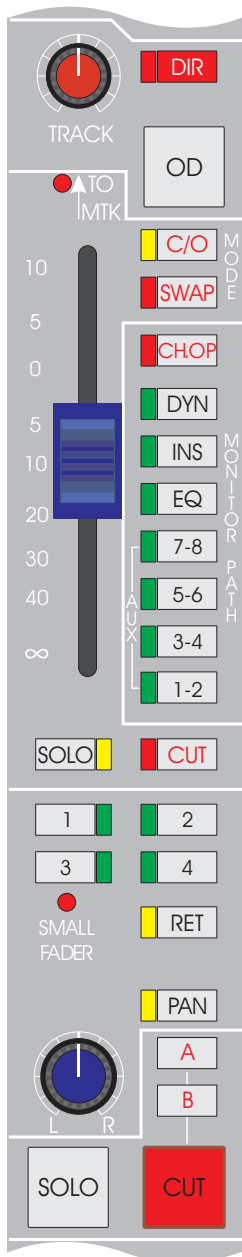

*Channel Strip  
Small Fader and  
Mixdown Module*

### Track Level Control

The track level signal can be controlled between -10dB and +10dB.

The channel signal can also be routed directly to the corresponding track send, avoiding the multitrack routing matrix.

In this mode, signals from other channels cannot be routed to this track send.

### Channel Status

Fader and status swaps can be achieved on an individual channel basis, overriding the global status controls on the Master Mode Select Panel.

### Monitor Path Selectors

The monitor path selectors assign the module dynamics, insertion, equaliser and auxiliaries to the monitor signal path.

The channel post-fade output can be connected to the input of the monitor path, allowing additional effects sends to be set up via the multitrack routing matrix.

The selector push-buttons are grouped for easy viewing so that the signal structure of each module may be quickly assessed.

### Monitor Path Switching

The console has a sophisticated monitoring system allowing monitoring freedom in the control room while the correct cue sends are retained.

The system works in conjunction with master monitor selection.

### **Solo and Cut Facilities**

The console has a sophisticated solo system with selectable momentary, interlocking and latching action push-buttons performing either in-place solo, or PFL or AFL type solos.

The two identical systems for the channel and monitor paths work regardless of fader swap.

The modules can be isolated from solo mute action to provide effects returns in both paths. Groups of large faders can be cut on a master basis by selecting one of two mute groups.

This action is always on the large fader regardless of positioning.

### **4-Track Routing Matrix**

Selectable access to the main outputs for mixdown and simultaneous monitoring during recording is available from the 4 track routing push-buttons with pan between odd and even outputs.

## Channel Faders

A Penny & Giles fader with associated automation controls.

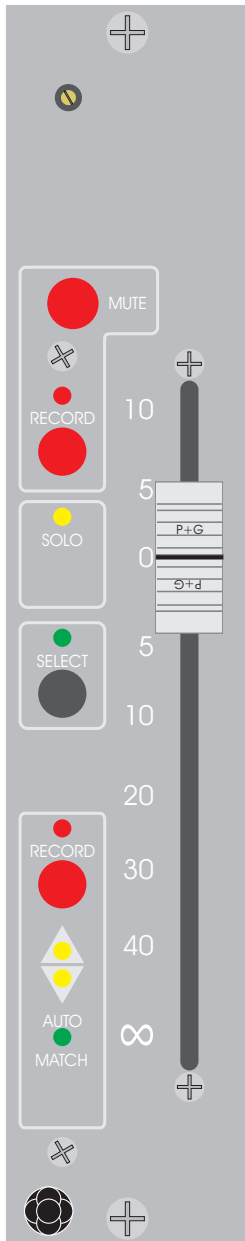

Channel Fader

### Mute

The Mute Button turns Mute On and Off.

The Mute Record button has an LED to indicate RSI (Ready, Safe, Isolate) and Touch Record/Lock Record for Mute.

The Mute Record Button toggles between Mute Touch Record/Lock Record modes. When RSI on the Global Master is enabled, this button (used in conjunction with SELECT) toggles through RSI for the Mute.

### Solo

Places a channel in/out of Solo and the LED indicates a channel is in Solo.

Solo must be enabled at the Global Master.

### Select

Used in conjunction with mute/fader RECORD for selection and interrogation of RSI, for the assignment and interrogation of Groups, Links and Solo banks, as a fader/mute touch indicator and as a relay control button.

### Fader Automation

#### Fader Record

This button toggles between Touch Record/Lock Record modes for the fader. When RSI on the Global Master is enabled, this button (used in conjunction with SELECT) is also used to toggle through fader RSI.

The LED acts as a recording indicator, RSI indicator, Touch Record and Lock Record indicator for the fader.

#### Match and Auto Match

The triangular LEDs indicate which direction the fader must be moved to return to the Play Pass position. They are also used for Group and Link interrogation.

The Match button is pressed to execute a Match. When used in conjunction with the fader RECORD button, Auto Match mode is activated.

The Auto LED indicates Match and Auto Match modes.



*The channel fader buttons shown here will be inoperative if the automation system is inactive.*

## Global Master Fader Controls

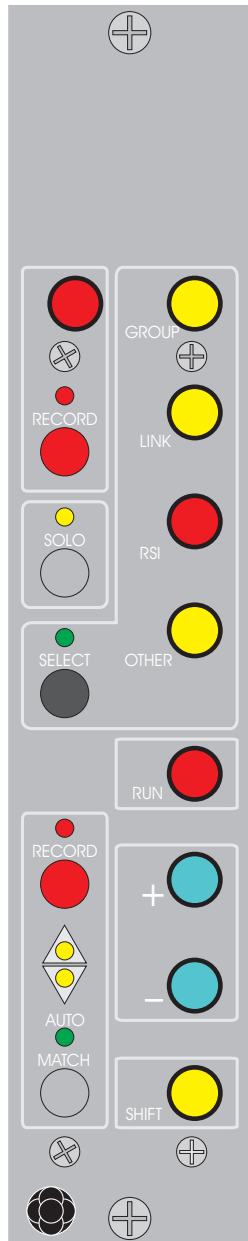

Master Automation Controls

Used for global control of the fader automation modes.

The Global Master has a duplicate set of the controls on individual channel faders, with additional controls in place of the fader.

 The directional match LEDs are inoperative on the Global Master.

### Additional Controls

GROUP enables/disables the Group assign mode.

LINK enables/disables the Link assign mode.

RSI enables/disables the RSI select mode.

OTHER enables/disables Trim, Graph, Set Solo Banks, Set Master Touch and Set Relay Control features.

RUN turns automation on/off.

The + and - buttons increment and decrement the Mix/Pass counter and apply Global Trim amounts.

SHIFT is used in conjunction with Plus (+) and Minus (-) buttons to change Mix numbers and apply Global Trim amounts. It is also used as a modifier for the OTHER and SOLO buttons and for 'Locking' Master Touch on.

 The buttons on the Global Master will be inoperative if the automation system is inactive.

## Meter Bridge

### Multitrack Meters

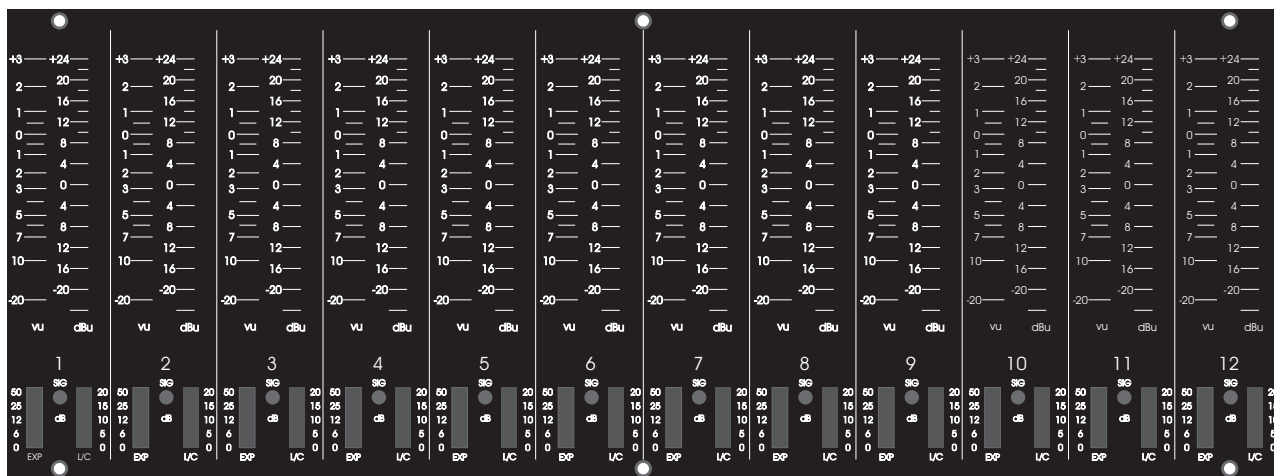

Multitrack Meters

The multitrack meters are numbered for each channel (i.e. 1 to 72 for a 72 channel console) and show the signal level on VU and PPM (dBu) scales with appropriate ballistics.

The display of VU or PPM metering is globally selected for all bargraph meters by the keys on the auxiliary VU meter panel. Users may display one, both or neither as required.

A 6dB Dump facility is provided for the VU bargraph meters which decreases the sensitivity of the meters by 6dB. This allows metering of signals which peak above +3 on the meter scale.

The DIGITAL CAL associated with the PPM meter key alters the bright up point for metering signals from a digital source.

Below the main bargraph meters are two small dynamics meters for the gate/expander (EXP) and limiter/compressor (L/C). They show the effect of settings within the dynamics module, and will not show anything when the dynamics are switched out.

The SIG LED has its threshold set from the Oscillator Panel. It allows the user to see there is a signal present, even though the signal may be too small to show on the meters. It also allows signal presence indication if both the main bargraph meters are disabled. The user may also set the threshold to a high level so that the LED indicates overload beyond the limit set by the user.

## Monitor and Phase Meters and TFT Screen

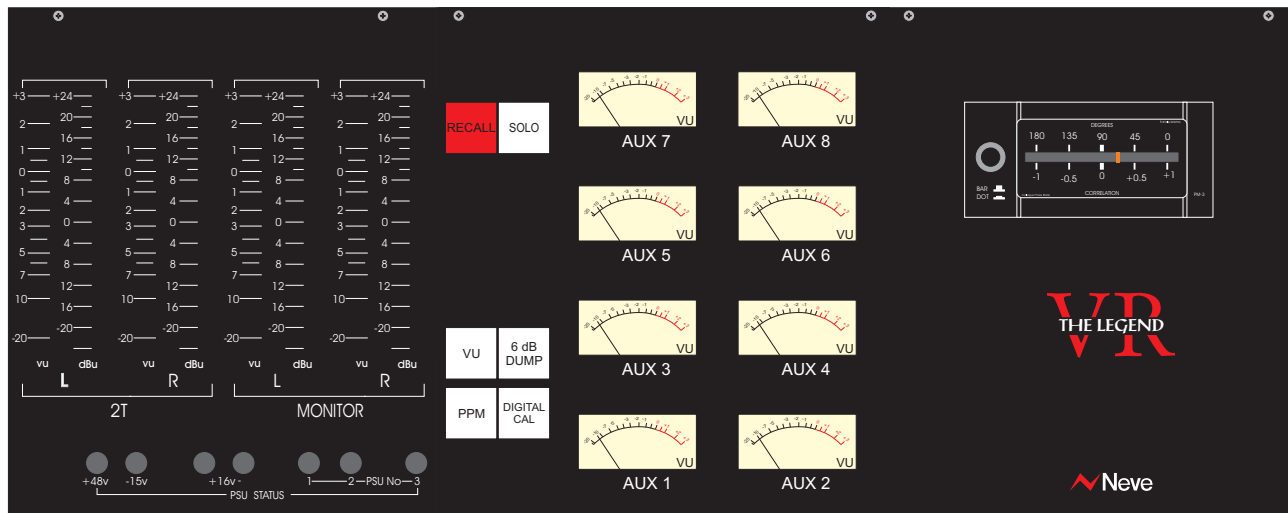

Monitor and Phase Meters and TFT Screen

### 2T and Monitor Meters

The display on these meters is controlled at the same time as the track meters from the keys on the auxiliary VU meter panel.

The 2T meters display according to the MIX 1-2, MIX 3-4 and EXT key selected on the Meters section of the Master Mode Select Panel. If EXT is selected, then the external source selected on the Monitor Select and Talkback Panel will be metered.

The MONITOR meters display the signal levels of the sound coming from the control room monitor speakers.

### Phase Meter

The phase meter shows the correlation between the right and left channels of the main output signals.

The display can be switched between bargraph mode (bar grows from the centre) and dot mode which lights a single LED at the current correlation point.

### PSU Status LEDs

The LEDs only illuminate when there is a problem with the relevant part of the power supply. There are three LEDs for each PSU, plus LEDs for phantom power (+48V), logic power rails (-15V) and audio supply rails (+16V and -16V).

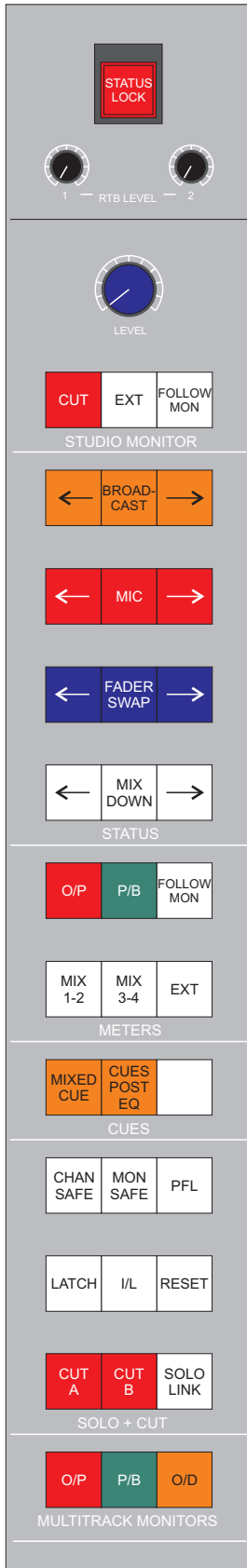

Master Mode Select Panel

## Monitor and Facilities

### Master Mode Select Panel

#### Console Status Configuration

Master switching allows the user to quickly configure the console using the status selectors, mic/line switching, fader swapping, tracklaying, mixdown status switching and broadcast selection. The console can be configured with great versatility including status assignment to allow split monitor operation.

The console status can also be changed on each I/O module on an individual basis.

Broadcast mode sources both primary and secondary signal paths from the mix inputs, providing 'simulcast' mixing which allows simultaneous multitrack and broadcast production work to be easily accomplished.

In Tracklaying mode the mic input of each channel is assigned to the primary signal path through the dynamics section, EQ and large fader to the multitrack routing matrix.

The multitrack return comes back to the small fader and from there to the main stereo outputs and stereo monitor.

To maintain headphone cue sends, if the Cut Solo function is selected, the Pre-fade auxiliaries are taken from a point prior to the muting action of the Solo-In-Place.

In Mixdown mode the multitrack is routed to the main stereo outputs via the line inputs and large fader.

The secondary monitor signal path becomes available to provide extra auxiliary sends or to add extra inputs to the mix.

#### In-line or split monitoring

Master switching operates over the entire console or on the left or right hand sections only.

This enables the console to be configured as an in-line console with primary and secondary signal paths in each module (one for the input signal and one for the monitor).

Alternatively one half of the console can be master switched to have inputs on the main faders and have full access to the EQ and dynamics sections and the other half can have the monitors assigned to the primary signal path.

Channels can also be switched on an individual basis.

### **Solo System**

All console solo push-buttons are electronically latched providing individual but identical solo facilities for both signal paths regardless of fader swap.

Keys on the Master Mode Select Panel determine the way the Solo button on each channel operates.

With no special function selected the operation is Solo-in-place (Cut Solo) with momentary switching.

It is possible to solo multiple channels by selecting and holding one channel's Solo button then momentarily pressing several more.

All solos will be cancelled when the first button is released.

The LATCH switch on the Master Mode Select Panel puts all Solo buttons into a latching mode.

All solos are cancelled when the master RESET button is pressed.

The I/L (interlock) button allows users to cancel previous solos when a new channel is selected to solo.

Each channel has a RET button (for 'Effects Return') which makes it safe from Solo-in-place.

This can also be linked to a tape machine's Record Ready tally or to an On-Air signal for auto changeover (allowing Solo-in-place to be used in situations where it might normally be avoided).

If Solo-in-place is not required conventional PFL and AFL are offered as alternatives by master switching on the central module.

### Monitor Select and Talkback Panel

#### Control Room Monitor

Allows stereo monitoring of selected sources on the control room speakers.

Up to sixteen external sources can be selected using the buttons above the EXT key.

Internal sources are selected using the buttons above the INT key.

The AFL/PFL key is used to grab the after-fader or pre-fader signal.

The selected source is metered on the MONITOR bargraph meter.

The other controls are for speaker selection, levels, balance, etc., without affecting the source signal.

The feeds to the control room monitor loudspeakers have insertions on the patchfield.

#### Talkback

Controls the sending of talkback to various destinations.

The levels to different destinations can be controlled independently with the rotary controls.

The RED LIGHT key is used to remotely switch a warning light such as 'Recording In Progress'.

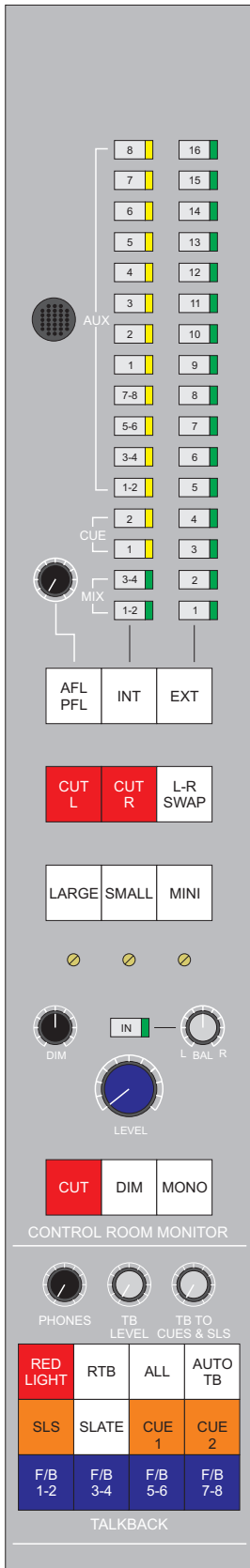

Monitor Select and Talkback Panel

### Oscillator Panel

The oscillator can be switched to frequencies of 40Hz, 100Hz, 400Hz, 1kHz, 4kHz, 10kHz and 15kHz.

Allows users to switch a calibrated level (set by the adjacent adjustment screw) to the selected oscillator outputs.

#### Signal LED Threshold

This rotary control sets the signal level at which the SIG LEDs on the track meters illuminate.

The SIG LEDs can be used for overload indication if the rotary control is set to a high value.

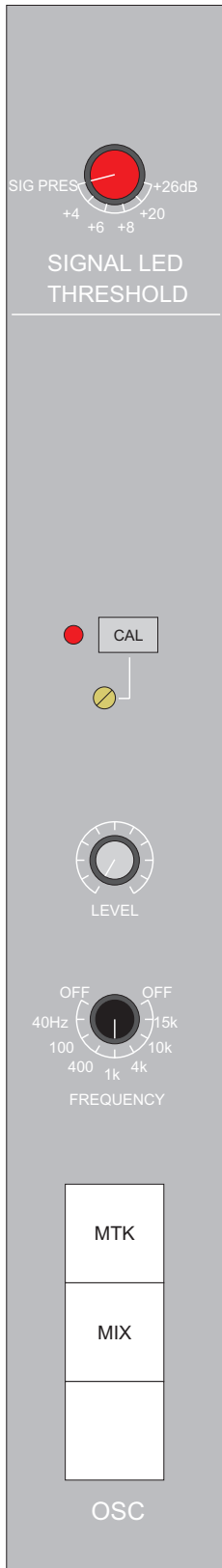

Oscillator Panel

### Auxiliary Master Panel

Allows users to configure the aux sends on the aux master panel as 8 mono aux sends or 4 mono stereo pairs with level and balance.

The master level controls feed the cue mix system and allow the user to build a mix of aux outputs as a cue mix.

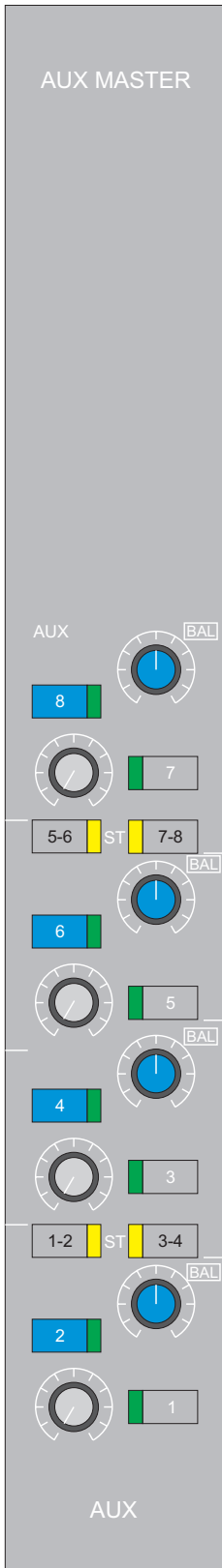

Auxiliary Master Panel

### Cue Mix Panels

Provides an intelligent Mixed Cue function.

Special monitor switching, operated from a tally from the multitrack, compensates for rises in level at the punch-in point (when two signals are mixed).

Provides two stereo cue sends with stereo equalisation, filtering, level and balance control.

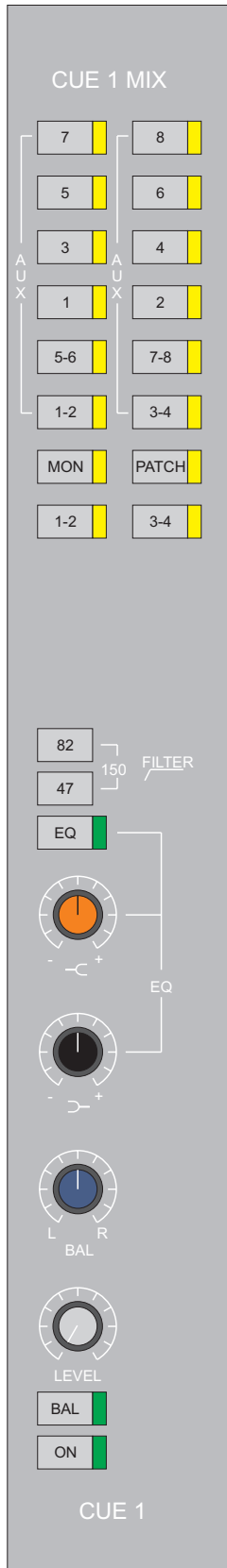

Cue Mix Panel

### Rev Return Panels

Provides facilities for up to four stereo reverberation/effects returns with stereo EQ, filtering, level and balance control.

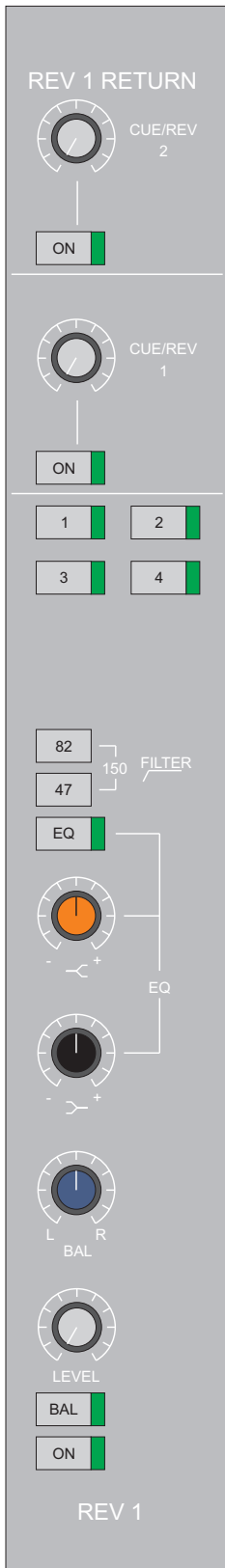

Reverberation Returns Panel

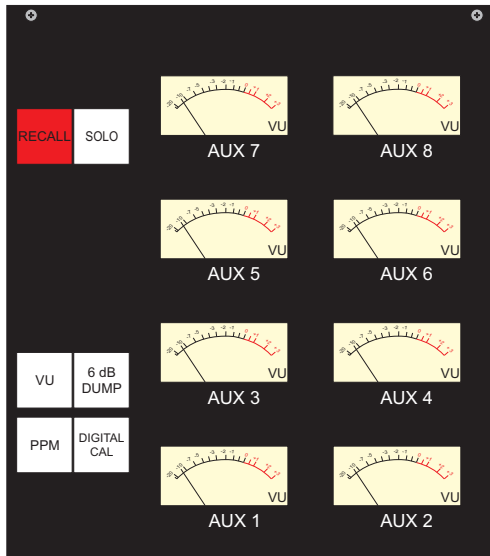

*Aux Meter Panel*

## Auxiliary Meters

### VU Meters

Dynamic VU metering of the auxiliary sends.

### Lights

RECALL illuminates when the Recall software is active.

SOLO illuminates when solo has been engaged anywhere on the console.

### Meter Control Keys

The keys determine the operation of the VU meters.

### VU and PPM

Allows users to select and deselect VU and PPM metering on all bargraph meters.

Users may display VU or PPM, both or none as required.

### DIGITAL CAL

Allows users to select digital or analogue calibration on the PPM bargraph meters.

This changes the 'bright up' point to 3 LED segments below +18 in digital mode, or 3 segments below +12 in analogue mode.

### 6dB DUMP

Allows users to dump (remove) 6dB of sensitivity from the VU bargraph meters.

This allows the meters to display signals which peak above +3 on the normal VU scale.



# ROUTING

Routing facilities are located in the Input/Output section of the channel module (strip).

## 48-track Routing



Channel Strip  
Multitrack Routing  
Module

A matrix of 24 multitrack assignment push-buttons and two 48-track routing push-buttons are used to select one or more of 48 output buses.

Depending on the state of the two 48-track routing push-buttons each assignment push-button will select either or both of two output buses.

### To route tracks 1 to 24

- Press the MTK 1-24 routing push-button.

The routing push-button LED will illuminate to confirm selection.

The buses in the range 1 to 24 will be selected.

### To route (switch) tracks 25 to 48

- Press the MTK 25-48 routing push-button.

The routing push-button LED will illuminate to confirm selection.

### If both routing keys are pressed

Each assignment push-button selects the appropriate bus in both ranges.

The routing push-button LED will illuminate to confirm selection.

## 2-track Routing

### Switch effects returns via the monitor path to 2-track outputs during mixdown

Effectively doubles the number of available line level inputs.

### To switch effects returns via the monitor path to one or both 2-track outputs during mixdown

- Press the 1, 2, 3 or 4 push-button.

These are located immediately below the multitrack switching matrix.

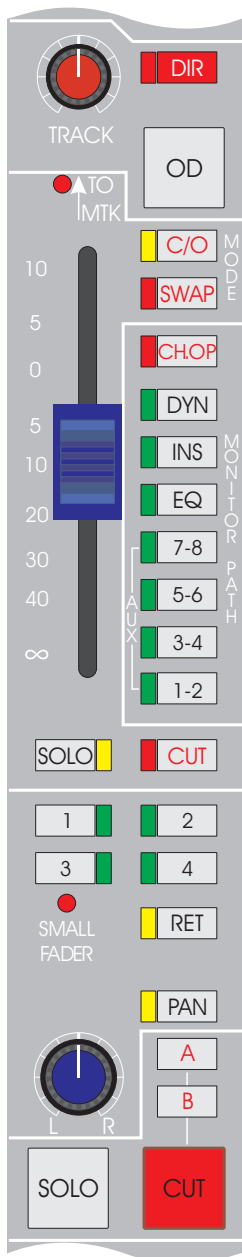

Channel Strip  
Small Fader and  
Mixdown Module

## Track Bounce

Connects the corresponding multitrack return (via the monitor path) to the multitrack routing matrix.

### To track bounce

- Press the B'NCE push-button on the Multitrack Routing Module.

The B'NCE push-button LED will illuminate to confirm selection.

### To select the bounced down track

- Press the required assignment push-button.

The 2-track routing is automatically cancelled to prevent doubling of the signal level.

## PAN the multitrack output

Enables the pan rotary control and allows panning between odd and even selections on the assignment push-buttons.

### To enable panning

- Press the PAN push-button.

The push-button LED will illuminate to confirm selection.

### To use panning

- Press the desired assignment push-button.
- Rotate the pan rotary control as desired.

## Direct routing

### To route back to the associated multitrack send

- Press the DIR push-button located in the TRACK section above the small fader.

The associated LED illuminates when subgroup is selected.

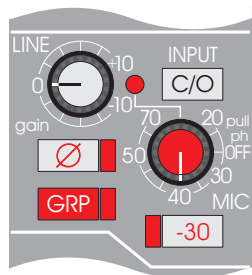

Channel Strip  
Input Module

## Input Section

Mic/line switching is master controlled and set depending on console status.

C/O flips the inputs locally in the opposite sense to the selected master status.

Both mic and line have continuously variable gain controls.

### Line trim control range

-10 dB to +10 dB with a centre detent(0).

### Mic input range

+20dB to +70 dB with the optional addition of a -30 dB pad.

With a total range of -10dB to +70dB, the mic input can be used for line level signals if desired.

### To flip the inputs locally in the opposite sense to the selected master status (i.e. mic/line changeover switching)

- Press the C/O push-button.

The adjacent red LED will illuminate when the I/O module input status is different to the master selection (made from the monitor panel).

### Patch free sub-grouping on any module

Allows the equalisers, filters, insertion and dynamics to be used on the multitrack signal (i.e. as if it were a conventional channel path input signal).

### To establish patch free sub-grouping

- Press the GRP push-button.

The channel path will now pick up the multitrack bus of the same number. The channel fader will now act as an audio subgroup fader and the signal can be routed in the usual manner.

### Ø (phase reverse)

Allows users to reverse/switch the phase on both mic and line input signals (but not the subgroup).

### To execute phase switching

- Press the Ø push-button.

The associated LED will illuminate to confirm selection.

### Phantom Power

Phantom power is provided by default on the MIC input.

#### To disable phantom power

- Pull up the MIC gain rotary control.

## Auxiliary Section

Eight mono auxiliary sends with level control and pre/post fader switching are provided, which may be assigned in pairs as stereo auxes with panning (i.e. AUX 1 and 2 are the first stereo pair).

#### To select up to eight mono aux sends

- Verify that the ST 1-2, 3-4, 5-6, 7-8 push-buttons are not currently enabled.

When disabled their LEDs will not be illuminated.

- Press the single number push-button (e.g. 1, 2, 3, 4, etc.) for the desired aux send.

The integral LED will illuminate when a push-button is pressed (selected).

#### To adjust mono aux send levels

- Use the associated rotary control.

The rotary controls located on the left of the aux module adjust even numbered aux send levels and the rotary controls located on the right of the aux module (marked PAN) adjust the odd numbered aux send levels.

#### To place the aux pre-fader

In its default state the aux will be post fader.

- Press the PRE push-button for the desired aux send.

The push-button LED will illuminate to confirm selection and the aux will be placed pre fader.

#### To select up to four stereo pair aux sends with panning

- Press the desired ST 1-2, 3-4, 5-6 or 7-8 push-button.

The integral LEDs will illuminate as the push-button is selected.

The PAN control becomes the balance control for the stereo pair, and the level control (for the even numbered aux in mono mode) controls the level of the stereo pair.

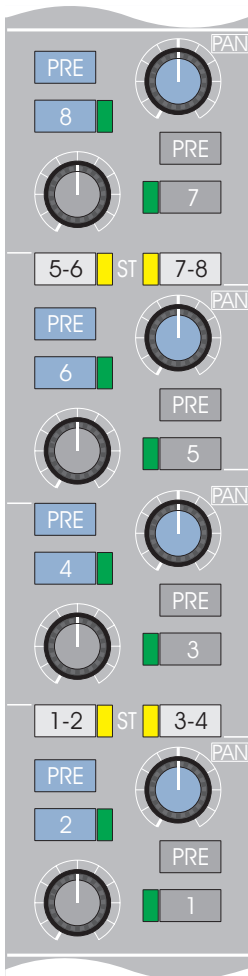

Channel Strip  
AUX Module

**To switch the stereo pairs on (i.e. enable the stereo pairs)**

- Press the 1, 3, 5 or 7 push-button as desired.

The LEDs for both push-buttons of the stereo pair are illuminated (e.g. if push-button 1 is pressed to enable the aux stereo pair on 1 and 2, the LED in push-button 2 will also illuminate).

**To place the stereo aux pair pre-fader**

In its default state the stereo aux pair will be post fader.

- Press the PRE push-button for the desired stereo aux pair.

The push-button LED will illuminate to confirm selection and the stereo aux pair will be placed pre fader.

**Pre/Post Cut**

How pre-auxiliaries are affected by the source path CUT key is determined (automatically) by the master mixdown/record switching status.

**If record is the current mode**

The auxiliaries are taken pre-path CUT, allowing in-place solos to be performed whilst sends to cues are unaffected.

**If mixdown is the current mode**

The auxiliaries are taken post-path CUT and effects sends are cut with source

**To select auxiliaries in pairs to the monitor path**

- Press the push-button marked AUX 1-2, AUX 3-4, etc, located adjacent to the small fader in the MONITOR PATH section.



*Auxiliaries stay assigned to the monitor or channel path independent of the fader swap system.*

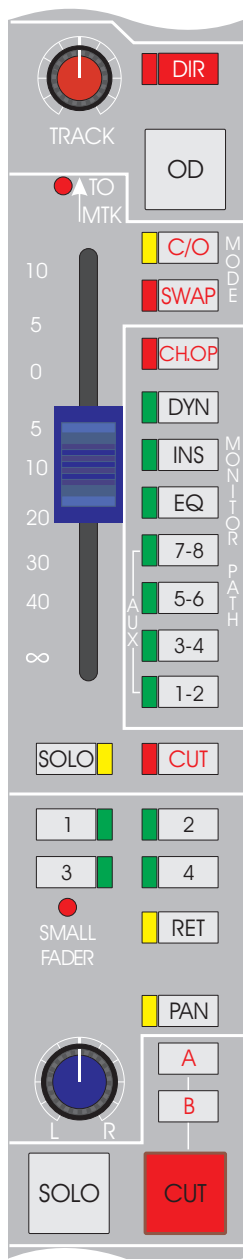

Channel Strip  
Small Fader and  
Mixdown Module

### Direct Routing

Route the channel output directly to the multitrack send of the same number and disable all other channels routed to that track (via the multitrack bus).

Used when a single channel path signal is all that is required to be sent to tape and the channel path can be configured on the same I/O module as the required track send.

#### To route the channel output to the multitrack send and disable other channels routed to that track

- Press the DIR push-button.

The DIR LED will illuminate to confirm selection.

### Signal level of the multitrack send

Allows users to adjust the signal level of the multitrack send (when routed via the multitrack bus or via the DIR push-button in the small fader section).

#### To adjust the signal level of the multitrack send

- Use the TRACK rotary control.

The control has a detented centre position at line-up level and 10dB of in-hand gain.

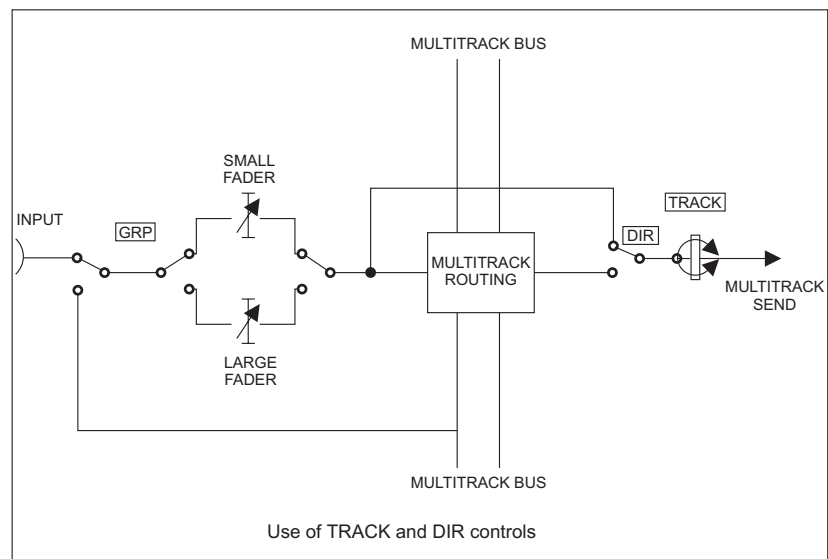

### **Reverse master status for record and mixdown modes on a local basis**

Allows the user to locally establish the status for record and mixdown modes with a single (electronically latching) push-button depression.

#### **To change over master status for record and mixdown modes on a local basis**

- Press the C/O push-button.

The integrated LED will illuminate to confirm selection (i.e. indicating that the local status is now the opposite of the master status).

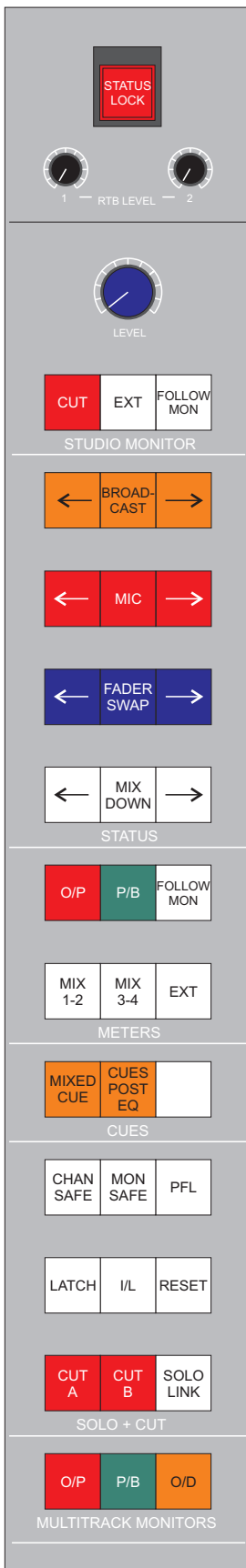

Master Mode Select Panel

## Swap small and large faders

Allows users to swap (i.e. transpose or change places) the small fader with the large fader (along with their associated solo and cut functions) on individual channel strips.

Users can also execute a global (i.e. the entire desk) fader swap.

### Small fader position displays

The position of the small fader is indicated by two LEDs.

The TO MTK LED above the small fader indicates that the fader is feeding the multitrack assignment matrix.

The LED above the main pan small fader rotary control indicates that the small fader is feeding the 4 Track routing matrix.

### Assigned auxiliaries

Auxiliaries remain assigned to the channel or monitor path independent of the swap function (i.e. replacing a small fader with a large fader or manual fader with an automated fader, does not reassign auxiliaries).

### To swap faders locally

- Press the SWAP push-button.

The integral SWAP push-button LED will illuminate to confirm selection.

### To swap faders globally (across the entire desk)

- Press the FADER SWAP key in the in Master Mode Select Panel.

The integral SWAP push-button LEDs on each strip will illuminate to confirm selection.

### To swap all faders on the left-hand side of the desk

- Press the  key at the left of the FADER SWAP key.

The integral SWAP push-button LEDs on each strip on the left-hand side of the console will illuminate to confirm selection.

### To swap all faders on the right-hand side of the desk

- Press the  key at the right of the FADER SWAP key.

The integral SWAP push-button LEDs on each strip on the right-hand side of the console will illuminate to confirm selection.

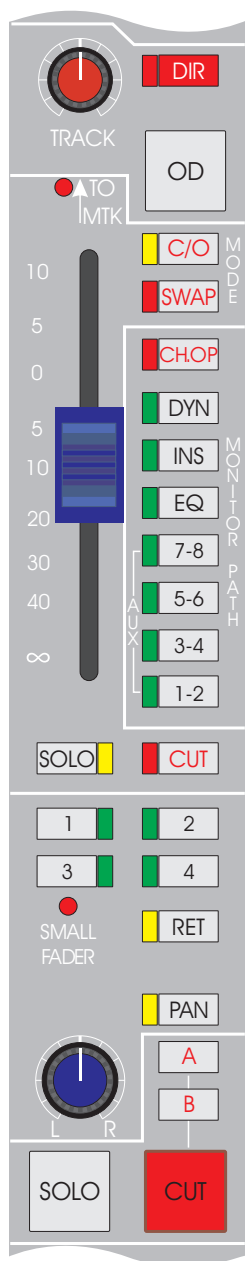

*Channel Strip  
Small Fader and  
Mixdown Module*

### Monitor path assignment

Allows users to connect the input of the monitor path to the channel post-fade output.

This provides up to 48 additional effects sends during mixdown.

#### To connect the input monitor path input to the channel post-fade output

- Press the CH-OP push-button.

The integrated LED will illuminate to confirm selection.

#### To assign dynamics into the monitor path

- Press the DYN push-button.

The integrated LED will illuminate to confirm selection.

#### To insert a patch into the monitor path

- Press the INS push-button.

The integrated LED will illuminate to confirm selection.

#### To assign eq into the monitor path

- Press the EQU push-button.

The integrated LED will illuminate to confirm selection.

#### To assign auxes in the monitor path

- Press the AUX 1-2, 3-4, 5-6 and 7-8 push-buttons as desired.

The integrated LEDs will illuminate to confirm selection.

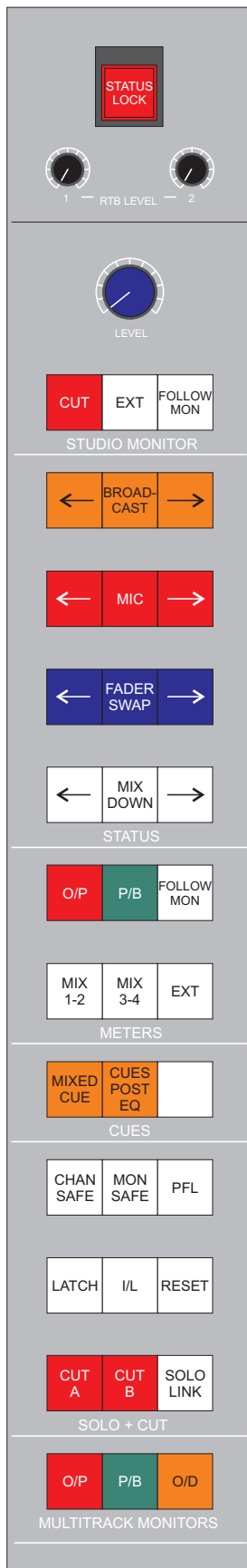

Master Mode  
Select Panel

## Solo and Master Cut System

Overall control of the separate monitor and channel solo systems is provided via the SOLO + CUT section of the Master Mode Select Panel.

Solo operations on the channel and monitor paths are separate unless SOLO LINK is selected.

### Fader Swap

Solo and cut operations work on either the monitor or channel path, regardless of which fader the path is going through.

For example, if only one strip was swapped and the large fader SOLO key was pressed on that strip, the LEDs on the CUT push-button for the small fader would illuminate on all the other strips.

If faders are swapped when solo and/or cut are in use, the illumination (or not) of the push-button LEDs and key lights also swaps to follow the monitor and channel paths.

The remaining instructions in this section on solo and cut assume that no faders have been swapped (i.e. the channel is on large faders and the monitor is on small faders).

### Latching, Interlocking and Momentary action

Solo may be operated in latching, interlocking or momentary action modes. Solo operations default to latching.

### Cut solo default status

The systems are normally in 'cut solo' mode unless the tape machine is in record mode or a safe mode has been selected.

### Cut solo indication

If a the signal on the large fader is cut due to solo being activated elsewhere, the CUT key will illuminate to half brightness to indicate cut solo.

The LED for the small fader CUT push-button does not have a half-brightness mode for cut solo. It will illuminate in cut solo the same as it does when pressed individually.

### Solo Safe mode

The path is not cut and solo monitoring is achieved by a separate stereo bus via the main monitor.

#### **If the tape machine is in record**

Solo safe is automatically set on the channel path and solo monitoring continues via the AFL/PFL busses.

#### **To enable solo safe mode**

- Press either the CHAN SAFE or MON SAFE key.

### To combine the monitor and channel solo systems

- Press the SOLO LINK key in the Master Mode Select Panel.

### AFL and PFL solo

The system (normally) provides positional AFL (after-faded listen) solo.

#### **To select PFL solo**

- Press the PFL key in the SOLO + CUT section of the Master Mode Select Panel.

### To cancel all current solos

- Press the RESET key in the SOLO + CUT section of the Master Mode Select Panel.

All solo keys and push-button LEDs will cease to be illuminated.

Any CUT keys and push-button LEDs which are not active will cease to be illuminated.

### Latching Solo

Latching turns solo on and off on individual strips. After the first solo has been pressed, other channels can be included in the solo by pressing their solo keys and/or push-buttons.

#### **To select latching solo**

- Press the LATCH key on the SOLO + CUT section of the Master Mode Select Panel.

The key will illuminate.

**To solo a channel or monitor path in latching mode**

- Press either the large fader SOLO key or the small fader SOLO push-button on the required strip.

The key or LED will illuminate, and the CUT keys and/or LEDs on other strips will illuminate to indicate they have been cut.

- Press other SOLO keys or push-buttons as desired.

This will include the signals on the selected paths in the solo.

**Interlocking Solo**

Releases a SOLO key (or push-button) as the next SOLO key (or push-button) is pressed.

**To select interlocking solo**

- Press the I/L key on the SOLO + CUT section of the Master Mode Select Panel.

The key will illuminate.

**To solo a channel or monitor path in interlocking mode**

- Press either the large fader SOLO key or the small fader SOLO push-button on the required strip.

The key or LED will illuminate, and the CUT keys and/or LEDs on other strips will illuminate to indicate they have been cut.

**To solo a different path**

- Press another SOLO key/push-button.

The previously selected solo will now be cancelled.

**To solo a group of paths**

- Hold down a SOLO key/push-button.
- Press other SOLO keys/push-buttons.
- Release the first SOLO key/push-button.

The selection will remain active until another SOLO key/push-button is pressed, or the RESET key is pressed.

## Momentary Solo

This causes the solo keys and push-buttons to only operate for as long as they are held down.

### To select momentary solo

- Press the LATCH and I/L keys together.

Both keys will illuminate.

### To solo a channel or monitor path in momentary mode

- Press and hold either the large fader SOLO key or the small fader SOLO push-button on the required strip.

The key or LED will illuminate, and the CUT keys and/or LEDs on other strips will illuminate to indicate they have been cut.

### To solo a different path

- Release the SOLO key/push-button being held down.

The solo will be cancelled.

- Press and hold another SOLO key/push-button.

### To solo a group of paths

- Hold down a SOLO key/push-button.
- Press other SOLO keys/push-buttons.

The selection will remain active until the SOLO key/push-button being held down is released.

## Cut facility

Allows users to operate the cut circuit individually or by master controls in conjunction with the A and B keys (located immediately above the CUT key).

### **To operate the cut circuit individually**

- Press the CUT key or push-button.

The key will illuminate to full brightness or the push-button LED will illuminate respectively.

### **If the circuit is cut by solo or by master control**

The lamp glows at half brightness.

### **If both master and individual cuts are activated**

The lamp glows at full brightness (indicating that if the master is released the path will still be cut). This applies in the same way to paths which have been cut by solo.

### **To cut a group of large faders**

- Press the CUT A or CUT B push-buttons on the required strips.



*CUT A and CUT B allow two separate groups to be set up.*

- Press the CUT A or CUT B key on the Master Mode Select Panel.

The key will illuminate.

The large faders with the corresponding push-button pressed in will have their signals cut.

### Mix Outputs

To access the main 2-track mix outputs for mixdown and simultaneous monitoring during multitrack recording

- Press the 1, 2, 3 or 4 push-buttons below the small fader.

The integrated LEDs will illuminate.

### Panning Mix Output Tracks

Allows panning between selected odd and even mix output tracks.

When pressed this key allows panning between selected odd and even mix output tracks.

#### To pan between selected odd and even mix output tracks

- Press the PAN push-button.

The integrated LED will illuminate and the adjacent pan rotary control will be enabled.

- Use the pan rotary control to pan between the odd and even mix output tracks.

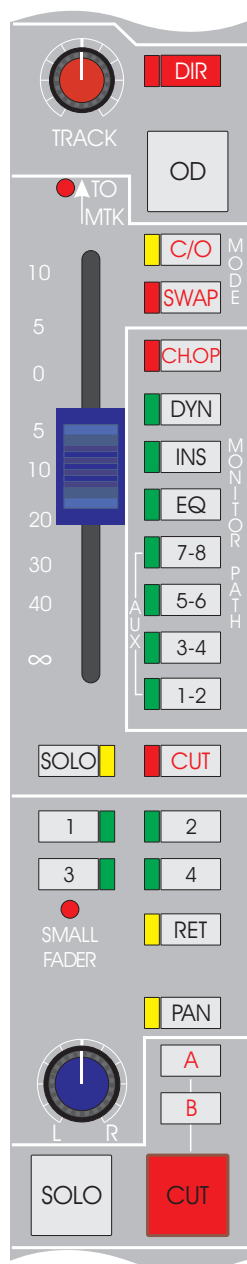

Channel Strip  
Small Fader and  
Mixdown Module

## Effects Return

Allows the I/O module to be used as an effects return (i.e. any path can be an effects return path).

If a path with effects send is soloed the operator needs to hear the 'effect' of the return mixed in with the source (in which case the return's path must not be cut).

In mixdown mode the monitor path may also be an effects return or send.

### To use the I/O module as an effects return

- Press the RET push-button below the small fader.

The integrated LED will illuminate.

## MONITORING

### Oscillator and Signal

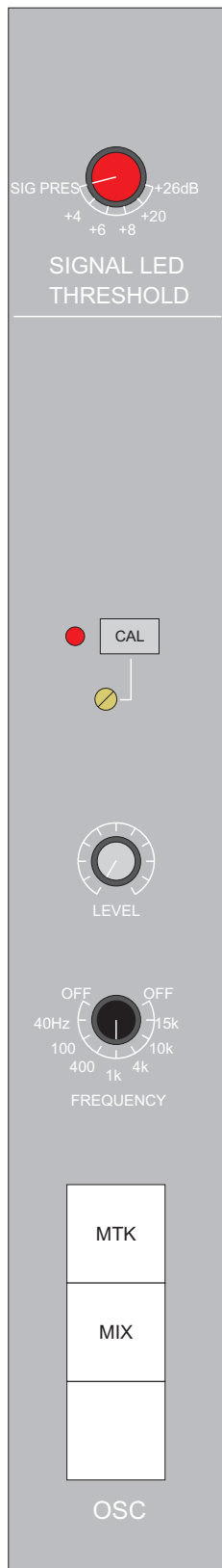

Oscillator Panel

The oscillator can be switched to frequencies of 40Hz, 100Hz, 400Hz, 1kHz, 4kHz, 10kHz and 15kHz.

#### To select oscillator frequencies

- Turn the FREQUENCY rotary control to the desired position located in the centre of the Oscillator Panel.

#### To adjust oscillator output level

- Turn the LEVEL rotary control to the desired position.

#### Switch the oscillator signal onto the console group outputs

Allows easy line-up of multitrack machines.

#### To switch the oscillator signal onto the console group outputs

- Press the MTK key.

#### Switch the oscillator signal onto the main 4-track outputs

#### To switch the oscillator signal onto the main 4-track outputs

- Press the MIX key.

The oscillator output is also available at the patchbay.

#### Calibration level

Allows users to switch a calibrated level for the studio (set by the adjacent adjustment screw) to the selected oscillator outputs.

-  The calibration level screw should only be adjusted by studio technical staff.

#### To switch in a calibrated oscillator level

- Press the CAL push-button.

The adjacent LED will illuminate.

The LEVEL rotary control will be disabled.

## Auxiliary Master Section

The auxiliary sends (located on the AUX MASTER panel) can be configured as eight mono auxiliary sends or four stereo pairs with level and balance.

### Stereo pairing

#### To make the 1 and 2 push-buttons act as individual switches for aux sends 1 and 2

- Ensure the ST 1-2 push-button is not pressed (i.e. not enabled).

The integrated LED will not be illuminated.

The operation of the other stereo pairs (3-4, 5-6 and 7-8) is similar.

#### To adjust individual aux master level controls

- Turn the adjacent rotary controls.

#### To switch the stereo pair on

- Press the ST 1-2 push-button.

The integrated LED will illuminate.

- Press the 1 push-button.

The LEDs in both the 1 and 2 keys will illuminate.

The switching action of the 2 key will be disabled.

#### To adjust the level for the pair

- Turn the rotary control associated with auxiliary 1.

#### To adjust the aux master balance

- Turn the BAL rotary control (associated with auxiliary 2) to the desired position.

### Master level controls

The master level controls feed the cue mix system, allowing the operator to build up a mix of auxiliary outputs as a cue mix.

The master level controls also adjust the level to the reverberation send outputs.

#### To enable the cue/reverb send outputs

- Press the 1 to 8 push-buttons.

Each send has a patch insertion.

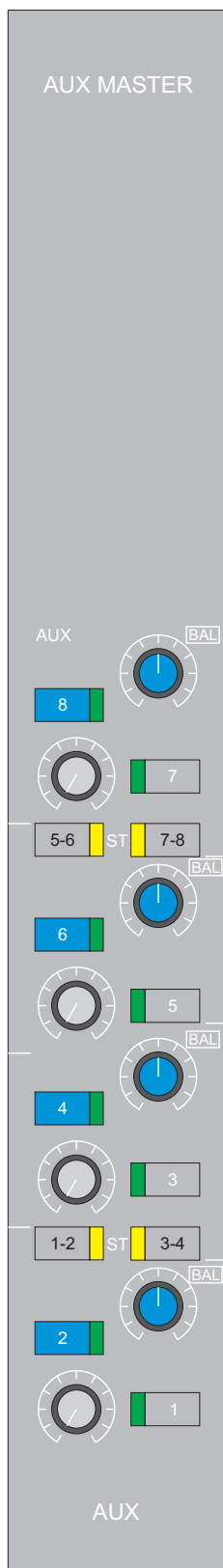

Auxiliary Master Panel

## Cue Mix System

Provides two stereo cue sends with stereo equalisation, filtering, level and balance control.

### To switch in the cue mix equaliser

- Press the EQ push-button.

The integrated LED will illuminate.

### High Pass Filter

The filter has three selectable cut-off frequencies.

#### To enable the high pass filter

- Press either the 47 or 82 push-button located above the EQ push-button.

#### To insert the filter with a cut off frequency of 150Hz

- Press both filter push-buttons together.

### To adjust cue mix balance

- Press the BAL push-button.

The integrated LED will illuminate.

- Turn the BAL rotary control to the desired position.

### To adjust cue mix level

- Turn the LEVEL rotary control to the desired position.

### To switch the signals through to the cue outputs

- Press the ON push-button.

The integrated LED will illuminate.

To create a mix of any of the auxiliary outputs (mono AUX 1 to 8 or stereo AUX 1-2 to 7-8) with the console 2-track mix outputs (1-2 and 3-4), control room monitor MON output, or dedicated patchbay PATCH stereo input

- Use the selection push-buttons located at the top of the module.

### Patch insertion for direct injection

Each cue output has a patch insertion for direct injection.

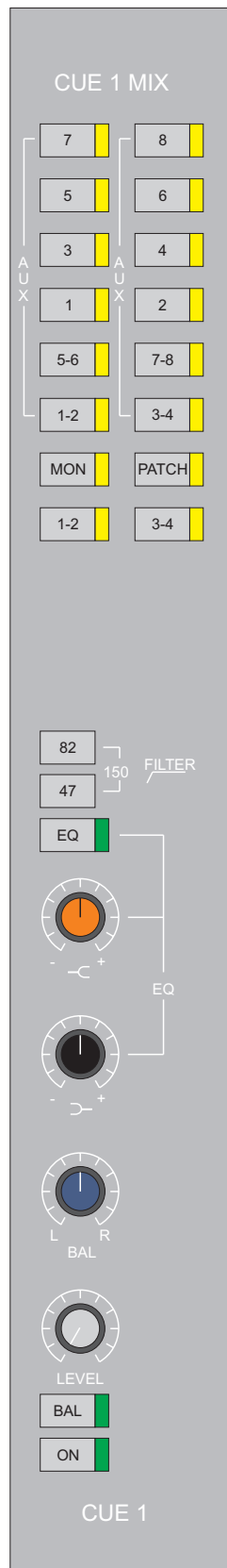

Cue Mix Panel



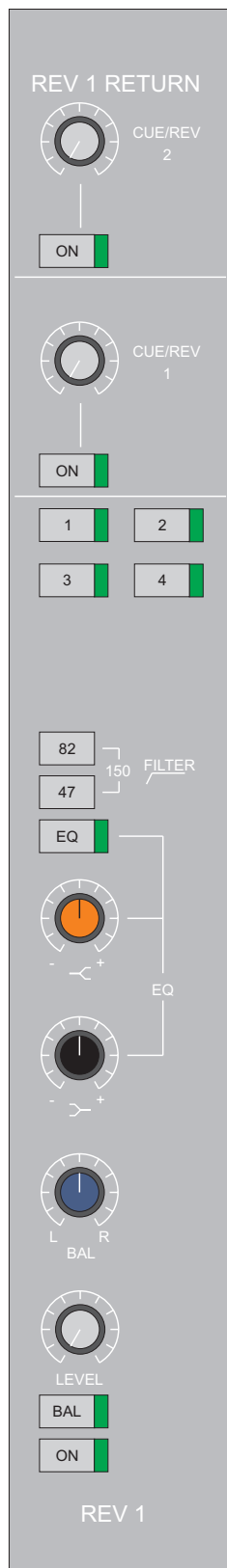

Reverberation  
Returns Panel

## Rev Returns

Provides facilities for up to four stereo, reverberation/effects returns with stereo equalisation, filtering, level and balance control.

### To insert the equaliser

- Press the EQ push-button.

The integrated LED will illuminate.

### High pass filter

The filter has three selectable cut-off frequencies.

#### To enable the high pass filter

- Press either the 47 or 82 push-button located above the EQ push-button.

#### To insert the filter with cut-off at 150Hz

- Press both push-buttons together.

### To adjust balance

- Press the BAL push-button.

The integrated LED will illuminate.

- Turn the BAL rotary control to the desired position.

### To adjust level

- Turn the LEVEL rotary control to the desired position.

### To switch the return signal onto the 2-track mix outputs as selected by 1, 2, 3 and 4

- Press the ON push-button.

### To add reverberation to the cue mixes

- Turn the CUE/REV 1 and 2 rotary controls.

### To enable the rev return sends

- Press the ON push-button below each control.

### Master Status Selection

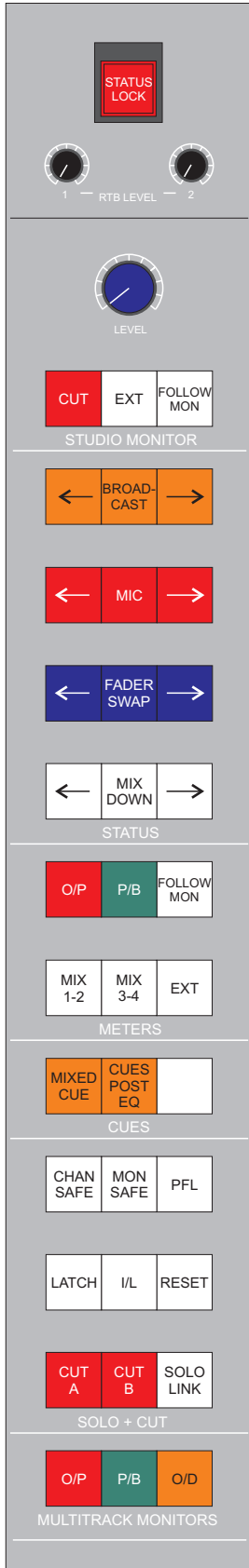

Master Mode Select Panel

To change the status of channels for the left hand side of the desk or the right hand side of the desk.

- Press the BROADCAST, MIC, FADER SWAP or MIXDOWN arrowed keys.

This allows the console to be configured with a separate monitor section.

To reset the whole console for that function

- Press the centre key for the desired function.

To reset the corresponding side of the console to that function

- Press either of the arrowed keys.

Reverse the selected master status

Each of the master controls has a corresponding pushbutton on each I/O module which reverses the selected master status.

An LED next to each module pushbutton indicates when that channel has reversed status compared with the master status.

To execute a master mic/line changeover

- Press the MIC key.

Illuminated keys indicate mic selection.

Fader swap

The normal power-up state (multitrack recording) is for the large fader to be in the channel path and the small fader to be in the monitor path.

The fader swap function reverses this condition for the entire console.

**To swap the large fader with its solo and cut with the small fader with its solo and cut**

- Press the FADER SWAP key.

**To reverse the faders on the left/right of the console**

- Press the associated left and right arrows.

The integrated LEDs illuminate to indicate that the swap has taken place.

### Mixdown

In MIXDOWN mode the monitor path is directed to the multitrack pan and routing keys (i.e. the small fader can control additional effects sends or returns).

In tracklaying mode the monitor path is directed to the main 2-track mix outputs for simultaneous monitoring.

#### **To alter the state of the paths from tracklaying mode to mixdown mode for multitrack tape playback and mixdown to 2-track**

- Press the MIXDOWN key.

The channel input is automatically set to line and the channel path is directed to the main 2-track mix outputs via the pan control (closest to the operator).

### Broadcast

Allows simultaneous broadcast and multitrack recording.

Fader swap is automatically engaged when BROADCAST is selected, Fader swap can be cancelled whilst broadcast is still engaged.

This facility allows the small fader to control the multitrack mix and the large fader to control the broadcast signal.

#### **To take the signal to pre-fade, post-equalisation and apply to the input of the secondary path**

- Press the BROADCAST key.

## Multitrack Monitoring and Overdubbing

The MULTITRACK MONITORS section of the Master Mode Select Panel switches the I/O module monitor paths between multitrack send and return.

In overdub mode the modules that have the individual overdub pushbuttons pressed are monitored as multitrack send. All other modules are monitored as multitrack return.

### To select multitrack send

- Press the O/P key.

Interlocked with P/B and O/D.

### To select multitrack return

- Press the P/B key.

Interlocked with O/P and O/D.

### To select overdub

- Press the O/D key.

Interlocked with O/P and P/B.

## Cue Sends

### **To send a mix of multitrack send and multitrack return to the monitor prefade cues on the I/O modules (which have individual OD keys selected)**

- Press the MIXED CUE key on the CUES section of the Master Mode Select Panel.

Switching the control room monitor to cues allows this mix to be monitored.

### **To switch cue sends on the paths that do not have individual OD selected to a 'follow monitor' condition**

(i.e. To allow backing tracks to be heard with the same frequency/dynamic correction as the control room monitor mix.)

- Press the CUES POST EQ key in the CUES section of the Master Mode Select Panel.

The facility automatically cancels should the engineer decide to monitor the console output using the master O/P pushbutton.

The backing track cue mix is still available to the artist (without processing) as it is now taken straight from the multitrack return.

With this system any loss of cue signal is prevented regardless of control room monitor condition.

## Control Room Monitor

Allows stereo monitoring of selected sources.

The feeds to the control room monitor loudspeakers have insertions on the patchfield.

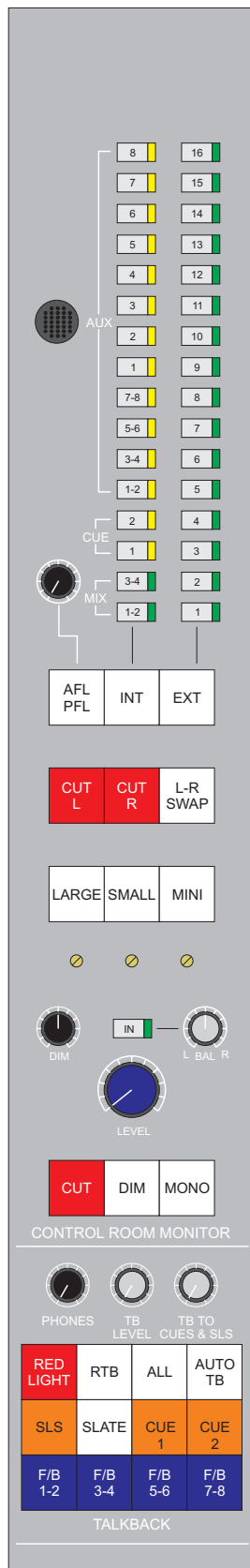

*Monitor Select and Talkback Panel*

### To dim monitoring

- Press the DIM key.

### To cut monitoring

- Press the CUT key.

### To mon-mix the monitoring

- Press the MONO key.

### To set the monitor dim level

- Turn the associated DIM rotary control.

### To offset the monitor signal up to 6dB

- Press the IN push-button.

The integrated LED will illuminate.

- Turn the BAL rotary control to the desired position.

### To adjust the monitor level of PFL/AFL signals

- Turn the rotary control located above the AFL PFL indicator monitor cut.

### To select left and right monitor cut individually

- Press the CUT L and CUT R keys as desired.

Momentary L-R SWAP can also be selected.

### To select one of three loudspeaker systems

- Press either the LARGE, SMALL or MINI key.

### To allow the level of each system to be adjusted individually

- Use the preset trimmers located immediately below the LARGE, SMALL or MINI keys.

### To adjust the master level control for all three (i.e. LARGE, SMALL or MINI)

- Turn the LEVEL rotary control.

## Monitor Selection

**To select of any one of 16 external stereo sources for 2-track playback**

- Press the EXT key.
- Press the desired selection of 1-16 push-buttons above the EXT key.

The integrated LEDs will illuminate.

**To monitor the auxiliaries, cues, and 2-track mix outputs**

- Press the INT key.

This key is interlocked with EXT.

- Press the desired selection of push-buttons (AUX 1 to 8, AUX stereo pairs 1-2 to 7-8, CUE 1 or 2, MIX 1-2 or 3-4) above the INT key.

The integrated LEDs will illuminate.

**If CHAN SAFE or MON SAFE in the SOLO+CUT section is selected and an individual channel/monitor SOLO pushbutton is pressed**

The AFL/PFL LED (next to the INT and EXT keys) illuminates (indicating that the main monitor has switched over to SOLO monitoring).

**To adjust the solo level**

- Turn the rotary control above the AFL/PFL indicator.

## Studio Monitor

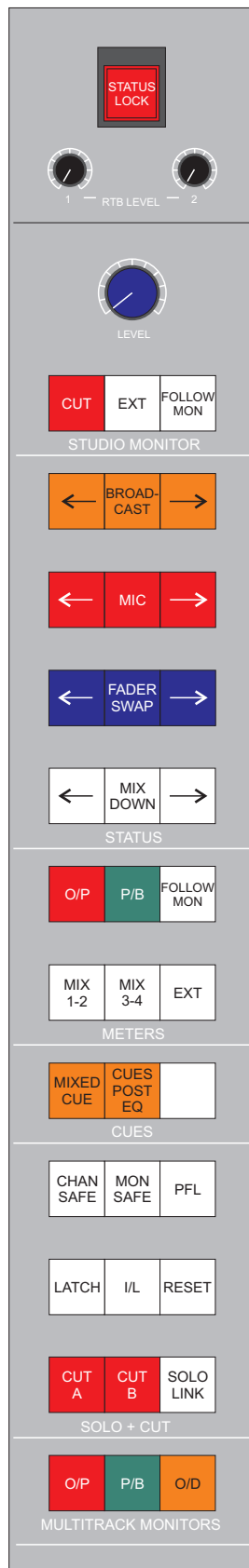

Master Mode Select  
Panel

### To cut the studio monitor

- Press the CUT key in the STUDIO MONITOR section of the Master Mode Select Panel.

The studio monitor is automatically cut when the RED LIGHT pushbutton on the TALKBACK section is engaged.

### To select the studio monitor to follow the control room monitor external source selector

- Press the EXT key in the STUDIO MONITOR section of the Master Mode Select Panel.

### To select the studio monitor to follow the control room monitor

- Press the FOLLOW MON key in the STUDIO MONITOR section of the Master Mode Select Panel.

### To adjust levels

- Turn the LEVEL rotary control to the desired position.

## Talkback System

Talkback to various destinations is controlled from the TALKBACK section of the Monitor Select And Talkback Panel.

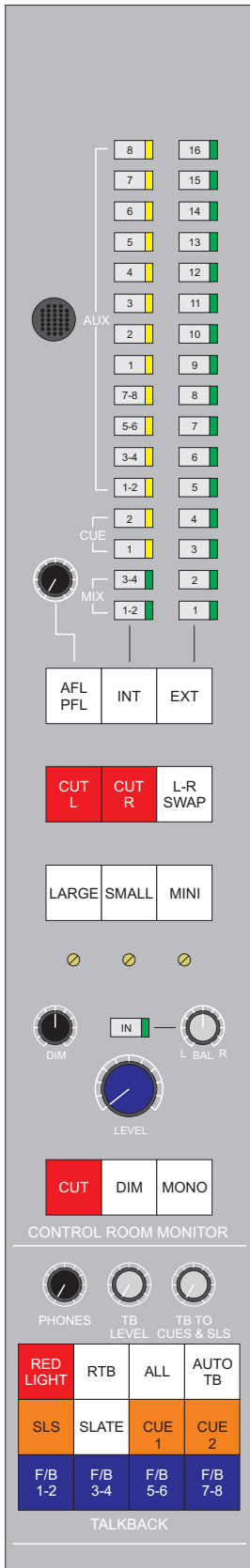

Monitor Select and  
Talkback Panel

### To send talkback to CUE 1 and CUE 2 respectively

- Press the CUE1 and CUE2 keys as desired.

The keys will illuminate when selected.

### To send talkback to all cues and the studio loudspeakers

- Press and hold the ALL key.

The key is momentary.

### To send talkback to the studio loudspeakers

- Press and hold the SLS key.

The key is momentary.

### To send the selected oscillator tone with talkback to the multitrack and two track outputs

- Press and hold the SLATE key.

The key is momentary.

### To open Cue 1 and Cue 2 talkback channels when the multitrack is 'passive' (parked or winding)

(And close the talkback when the transport is in PLAY.)

- Press the AUTO TB key.

This key is latching and will illuminate when selected.

### To return talkback from the studio to the control room

- Press the RTB key.

This key is latching and will illuminate when selected.

### To adjust the level

- Turn the RTB LEVEL 1 and 2 rotary controls (located in the STUDIO MONITOR section of the Master Mode Select Panel) to the desired position.

### To adjust the headphone level

- Turn the PHONES rotary control to the desired position.

This rotary control provides level adjustment for the headphone jack socket located in the console leg.

**To adjust the talkback level**

- ▶ Turn the LEVEL rotary control.

**To illuminate the studio warning light (e.g. 'Recording In Progress')**

- ▶ Press the RED LIGHT key.

The key will illuminate.

**To send talkback to the auxiliaries as cue sends in pairs**

- ▶ Press and hold the F/B 1-2, F/B 3-4, F/B 5-6 and F/B 7-8 keys as desired.

These keys are momentary.



# METERING

## Multitrack Meters

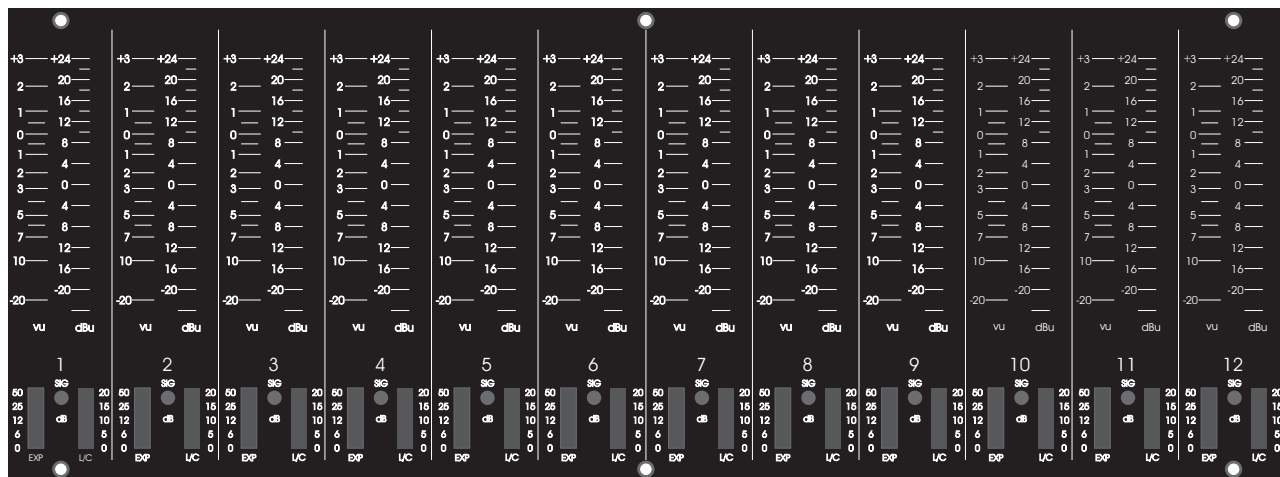

Multitrack Meters

The track meters have both VU and PPM bargraph meters with appropriate ballistics for displaying signal levels.

Below the main bargraph meters are a signal presence LED and two small dynamics meters.

### Volume Unit Meter

Provides a scale from -20dB to +3dB, the zero point would normally be employed as the studios electrical reference point.

#### To enable VU metering

- Press the VU key on the Aux Meter Panel.

The key will illuminate.

All the VU bargraph meters on the console will be enabled.

#### To reduce the sensitivity of VU metering

- Press the 6 dB DUMP key on the Aux Meter Panel.

The key will illuminate.

All the VU bargraph meters will show signals 6dB below the actual value.

Signals which peak above +3 on the VU scale should now display within range.

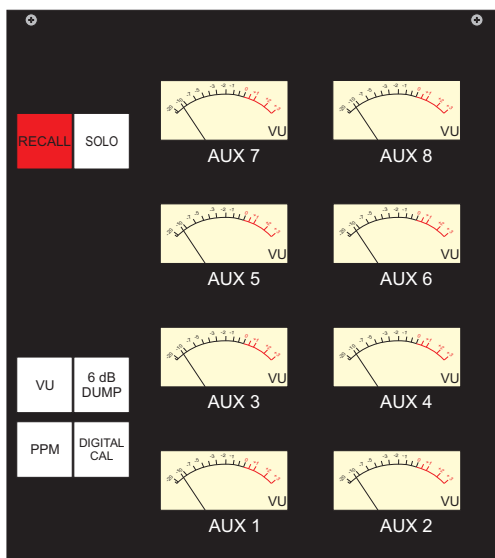

Aux Meter Panel

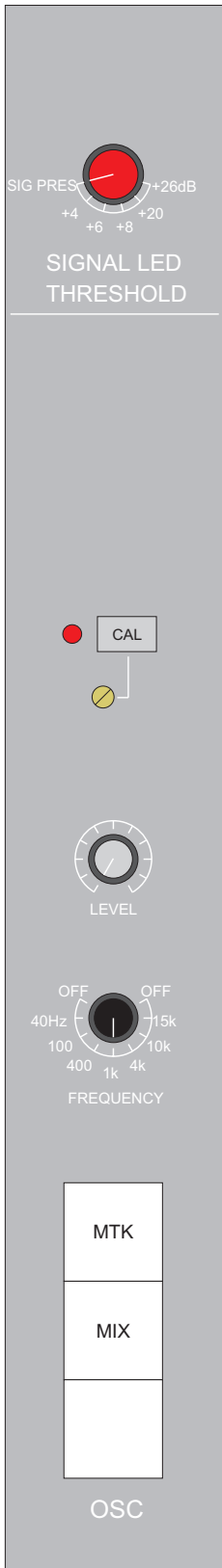

Oscillator Panel

### Peak Program Meter

Provides a scale from -20dBu to +24dBu. The 'bright up' point is normally set at 3 segments below +12dBu for metering signals with analogue sources.

#### To enable PPM metering

- Press the PPM key on the Aux Meter Panel.

The key will illuminate.

#### To change the bright up point on the PPM bargraph meters to 3 segments below +18dBu

- Press the DIGITAL CAL key on the Aux Meter Panel.

The key will illuminate.

* This setting is intended to allow for a higher overload point when working with signals with a digital origin.*

### Signal Presence

The SIG LED shows signal presence according to the Signal LED Threshold setting on the Oscillator Panel.

#### To set the SIG LED illumination point

- Turn the Signal LED Threshold rotary control to the desired value.

#### To use the SIG LED as an overload indicator

- Set the Signal LED Threshold rotary control to a high value.

### Selecting The Metered Signal

#### **To meter the multitrack send signal**

- Press the O/P key on the METERS section of the Master Mode Select Panel.

#### **To meter the multitrack return signal**

- Press the P/B key on the METERS section.

#### **To make the metering follow the multi-track monitor selection**

- Press the FOLLOW MON key on the METERS section.

The multitrack meters will now display according to the selections made on the MULTITRACK MONITOR section of the Master Mode Select Panel.

## Control Room Monitor Metering

Two bargraph meters (labelled MONITOR) are permanently attached to the control room monitor for metering the left and right signals routed to the control room speakers (i.e. any of the desk sources or 16 external sources selected for control room monitoring).

See Monitoring for more information on control room monitor source selection.

### Metering Type

The meter display type (VU, PPM or both) is controlled by the keys on the Aux Meter Panel at the same time as the multitrack meters.

See Multitrack Metering above for instructions on altering the meter displays.

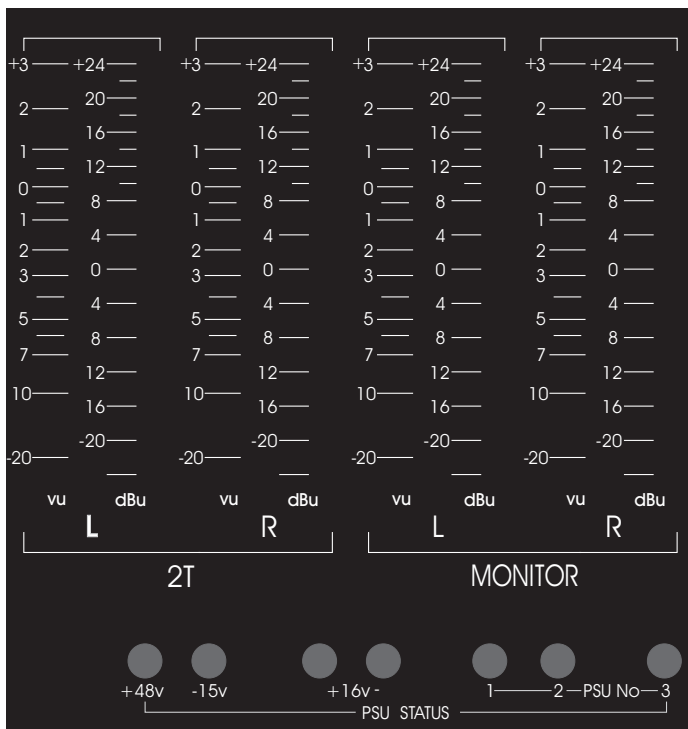

*Main Output Meters*

### Output Metering

The display of the 2T bargraph meters is controlled by the 3-button interlocked selector located in the METERS section of the Master Mode Select Panel.

The 2T meters are normally used for metering of the 2-track console mix outputs by selecting MIX 1-2 or MIX 3-4.

They can also be used to meter the external source selector on the control room monitor.

#### To meter the mix output on tracks 1 and 2

Press the MIX 1-2 key on the METERS section.

#### To meter the mix output on tracks 3 and 4

Press the MIX 3-4 key on the METERS section.

#### To meter the external source selected on the control room monitor

➤ Press the EXT key on the METERS section.

#### Metering Type

The meter display type (VU, PPM or both) is controlled by the keys on the Aux Meter Panel at the same time as the multitrack meters.

See Multitrack Metering above for instructions on altering the meter displays.

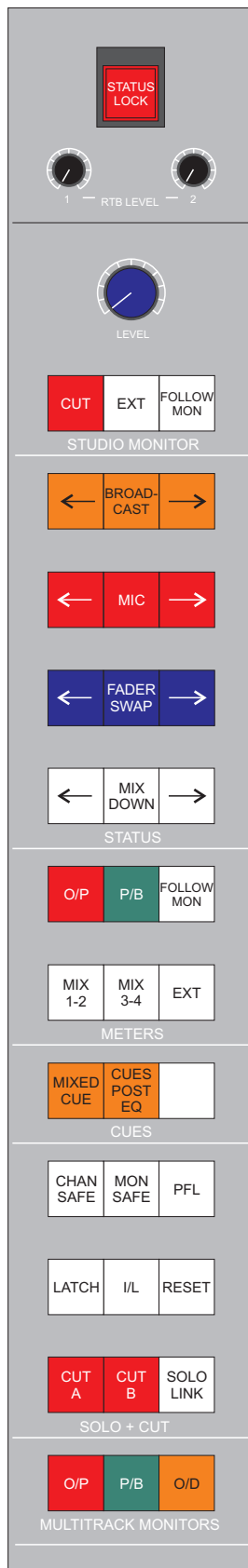

Master Mode Select Panel

### Aux Meters

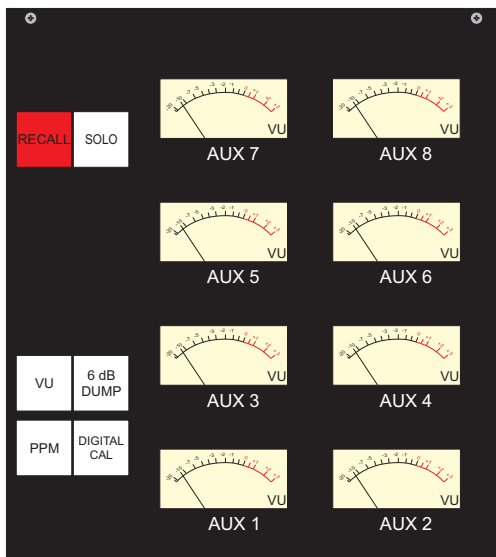

Aux Meter Panel

There are eight dynamic VU aux meters (1-8) which show the signal levels on the aux sends.

The panel also has lights to show if SOLO is being used anywhere on the console, and if the RECALL software is active.

The group of four keys (VU, 6dB DUMP, PPM and DIGITAL CAL) are for global control of the bargraph meters on the meter bridge - see Multitrack Metering for an explanation of their operation.

## Phase Meter



Phase Meter

The phase meter is only significant when the main output is stereo.

The meter displays as a bargraph style growing from the centre or a moving dot (one LED illuminated only).

Each LED shows 9 degrees resolution.

The centre LED is yellow. The lower LEDs are red, and the upper LEDs are green.

Full scale green shows a fully mono signal and full scale red shows a completely out of phase pair of signals.

### To change the meter display to a moving dot

- Press the BAR/DOT button so that it remains depressed.

### To change the meter display to a bargraph style

- Press the BAR/DOT button again.



## **PROCESSING (DYNAMICS and EQ)**

---

### **Channel Processing**

#### **Input Filter**

The input filter consists of a high and low pass filter.

#### **Dynamics Module**

The dynamics module is arranged with the gate/expander located on the left hand side of the module and the limiter/compressor on the right.

The gate/expander and limiter/compressor are switched in and out of the signal path independently.

#### **Insertion and Equaliser Module**

Provides an independently switchable patch insertion and four band equalisation.

### **Cue Mix and Rev Return**

The Cue Mix and Rev Return panels also have their own integral equaliser controls.

See the Monitoring chapter for more details.

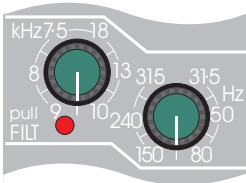

VRL Channel Strip  
Input Filter Module

## Input Filter

### High pass

The high-pass filter has a range of 31.5Hz to 315Hz.

### Low pass

The low-pass filter has a range of 7.5kHz to 18kHz.

 Both filters are “smooth” controls.

### Filter slope

The filter slope is 12dB/octave for both filters.

### To select high-pass/low-pass filter

- Pull up the desired FILT rotary control.

The FILT LED will illuminate (when either or both filters are selected).

- Rotate the control to the desired value.

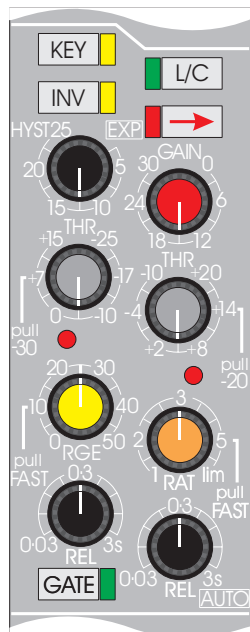

VRL Channel Strip  
Dynamics Module

## Gate/Expander

### To enable the Gate/Expander

- Press the GATE push-button on the dynamics module.

The GATE push-button LED will illuminate and the Gate/Expander is placed in the signal path.

### External Gate/Expander Trigger

#### To enable the gate to be triggered by an external device or any other path signal

- Press the KEY push-button.

The KEY push-button LED will illuminate.

A dedicated patch input to the Gate/Expander is provided.

The compressor operation is not affected.

### Invert

Allows the user to close the gate when a signal of the required level is present.

Used as a 'ducker' (i.e. cutting out background noise) or for muting severe breakthrough from another source.

#### To close the gate when a signal of the required level is present (i.e. invert the external trigger control)

- Press the INV push-button.

The INV push-button LED will illuminate.

### Hysteresis

Hysteresis is the difference in dB between the muted gate level and its un-muted level. Varying the hysteresis allows more precise triggering of the wanted signal while at the same time allowing the correct amount of signal tail to pass through.

-  10dB of hysteresis is a good starting value for setting the gate.

#### To adjust hysteresis

- Turn the HYST rotary control.

Hysteresis is present at all times.

#### To switch the circuit into a 2:1 ratio expander

- Turn the HYST rotary control to the EXP position (i.e. fully anti-clockwise).

### Threshold

Provides threshold control over 70dB in two overlapping ranges.

**To set the difference in dB between the muted gate level and its un-muted level**

- Turn the THR rotary control to the desired value.

**To change the threshold range by -30dB**

- Pull up the THR rotary control.

The associated red LED will illuminate to confirm the action.

-30dB will be added to the panel values.

- Adjust the THR rotary control as desired.

### Gate range (mute depth)

Allows users to set the range (mute depth) of the gate over a 50dB range.

**To set the range of the gate**

- Turn the RGE rotary control to the desired value.

**To change the attack time from 1ms to 100us**

- Pull up the RGE rotary control.

### Gate/expander release time

The release time for the gate/expander is continuously variable from 30ms to 3s.

**To set the gate/expander release time**

- Adjust the REL rotary control as desired.

## Limiter/Compressor

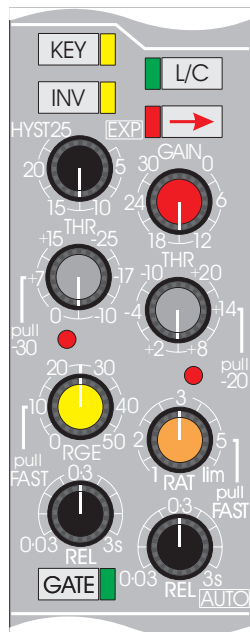

VRL Channel Strip  
Dynamics Module

### To enable the Limiter/Compressor

- Press the L/C push-button.

The L/C push-button LED will illuminate to confirm selection and the Limiter/Compressor is placed in the signal path.

### Stereo pair linking

Allows the user to link the limiter/compressor to the module located immediately to its right-hand side, forming a stereo pair.

The link can also be made if the limiter/compressor is not in circuit (so that it can be used for a stereo/quad link even if it is not actively processing).

### To form a stereo pair or establish quad ganging

- Press the  push-button.

The associated LED will illuminate to confirm selection.

### Gain make up

Gain make-up of up to 30dB allows the user to maintain an optimum signal to noise ratio throughout the path (even under heavy compression).

### To adjust gain

- Turn the GAIN rotary control.

Gain is present at all times.

### Threshold ranges

The threshold level can be controlled over 50dB in two overlapping ranges.

### To establish the threshold level

- Turn the THR rotary control to the desired value.

### To change the threshold range by -20dB

- Pull up the THR rotary control.

The associated red LED will illuminate to confirm the action.

-20dB will be added to the panel values.

- Adjust the THR rotary control as desired.

### Compression Ratio

Allows users to select the compression ratio with an arranged law between 1:1 and limiting (1 and lim).

#### **To establish the compression ratio**

- Turn the RAT rotary control to the desired value.

#### **To change the attack time from 1ms to 100us**

- Pull up the RAT rotary control.



*Pulling up the ratio control nominally increases the impulse attack time from 1ms to 100us, however the attack time is actually programme dependent, normally having a 7ms time constant (with faster time constants applied to transient programme material).*

### Release time

Allows users to establish the release time from 30ms to 3s with automatic 'hold' and impulse release circuits to remove pumping and breathing effects.

#### **To adjust the release time**

- Turn the REL rotary control to the desired position.

#### **To switch the release control to a triple time constant programme dependent release time**

- Turn the REL rotary control in a clockwise direction until it can not be turned any further (i.e. 3s).

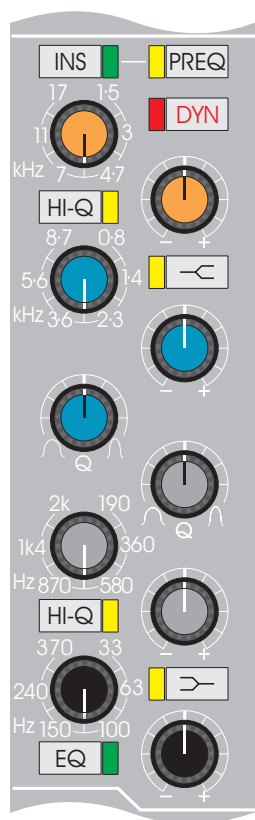

VRL Channel Strip  
Equalisation Module

## Insertion

Provides users with an independently switchable patch insertion.

### To switch the insertion facility into the signal path

- Press the INS push-button.

The INS push-button LED will illuminate to confirm selection.

### To switch the insertion out of the path

- Press the INS push-button again.

The LED will cease to be illuminated.

 *The insertion will provide an output regardless of the INS key state.*

### To switch the insertion facility in/out of the monitor path

- Press the INS push-button located adjacent to the small fader.

The INS key LED will illuminate to confirm selection.

### To switch the insertion out of the monitor path

- Press the INS push-button adjacent to the small fader again.

The LED will cease to be illuminated.

 *The insertion will provide an output regardless of the INS push-button state.*

## Insertion pre/post-equaliser and dynamics

When selected insertion is normally post-equaliser.

### To switch the insertion pre-equaliser and dynamics

- Press the PREQ push-button.

The PREQ push-button LED will illuminate to confirm selection.

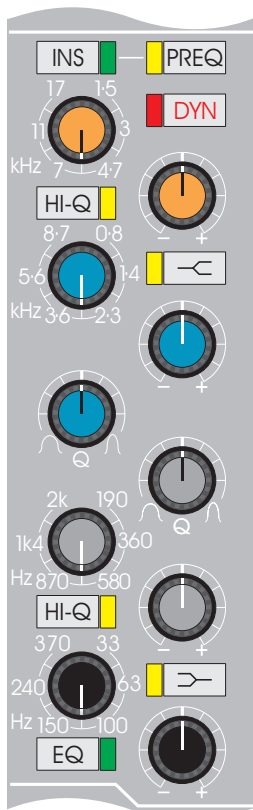

VRL Channel Strip  
Equalisation Module

## Equaliser

The equaliser consists of four continuously-variable overlapping frequency bands with a peaking characteristic.

Users can switch from peak to shelving.

### Frequency control ranges

- Low: 33Hz to 370Hz
- Mid1: 190Hz to 2kHz
- Mid2: 0.8kHz to 8.7kHz
- High: 1.5kHz to 17kHz

### Q varies with gain

Q automatically varies with gain on all bands in peaking and shelving modes (as gain is increased so is Q).

### Rotary controls

The tops of the rotary controls EQ\_module are colour coded to distinguish the controls for each band of EQ.

- Low Black
- Mid1 Light grey
- Mid2 Pale blue
- High Orange

### To switch the equaliser into the circuit

- Press the EQ push-button.

The integral LED will illuminate to confirm selection.

- Adjust EQ frequency as desired using the rotary controls.

### Mid Band Q

The mid band equalisers (pale blue and light grey rotary controls) have variable Q adjusted across a range of 0.5 to 9.

The rotary controls have a centre detent at Neve FSE traditional settings.

### To adjust mid band Q

- Turn the Q rotary controls to the desired position.

### High and Low Band Q

The Q and characteristics of the high and low bands can be switched from 0.71 to 2.

#### **To switch the Q and characteristics of high/low bands from 0.71 to 2**

- Press the desired HiQ push-button.

The HiQ push-button LED will illuminate to confirm selection.

### Peak and Shelving

The high and low band equalisers are switchable from peak to shelving.

#### **To switch high band EQ from peak to shelving**

- Press  the push-button.

The integral LED will illuminate to confirm selection.

#### **To switch low band EQ from peak to shelving**

- Press  the push-button.

The integral LED will illuminate to confirm selection.

### Cut/Boost

All four bands have a smooth rotary control each for adjusting cut or boost over an 18dB range.

#### **To adjust cut or boost in an equaliser band**

- Turn the appropriate cut/boost rotary control to the desired position.

## Sidechain Equalising

Allows users to insert the module equaliser into the control Sidechain of the dynamics unit.

### To insert the equaliser into the control sidechain of the dynamics unit

- ▶ Press the DYN push-button in the equaliser module.

The DYN push-button LED will illuminate to confirm selection.

# FADER DIRECT INPUT MODULE (Optional)

## Facilities

The Fader Direct Input Module provides a Direct to Fader Input facility on the Channel Section of the input module.

This provides the capability to by-pass the entire front end of the console, allowing users who want a sound different from the AMS Neve VRL console to use an alternative front end (e.g. AMS Neve 1081 Channel Amplifiers). Also, a perfect signal from the mic or tape can be applied directly to the fader without passing through unused signal path and switching elements.

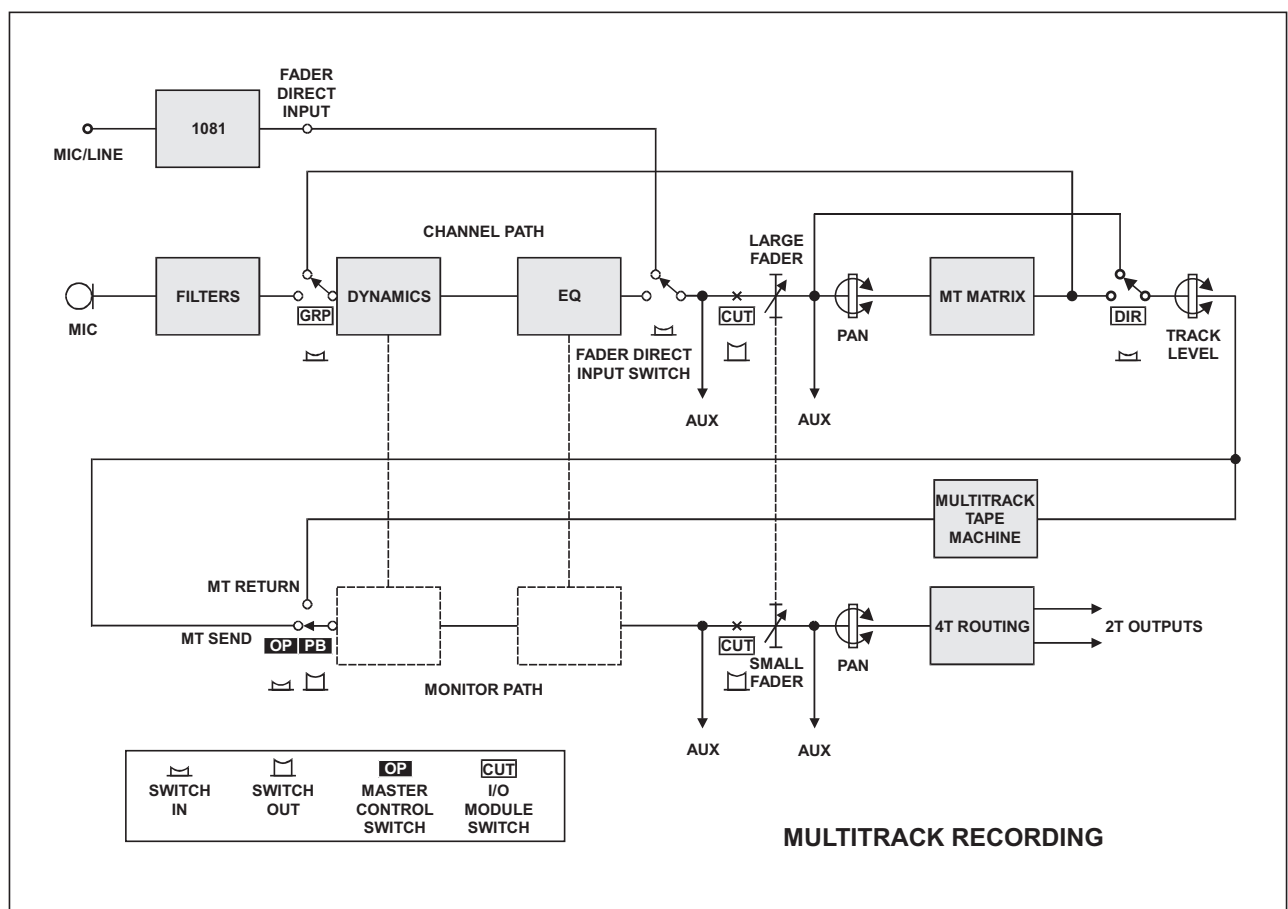

Fader Direct Input Signal Path

The Fader Direct Input is controlled by a bank of push-buttons in the Monitor section of the console. There is a SAFE push-button for each bank of 12 modules to prevent accidental changeover in mid-track. All channel modules in the console are fitted with the Direct to Fader input. The control switches are arranged in banks of 12. The input switching can be controlled as an event by the automation system.

## Using the Fader Direct Input Module

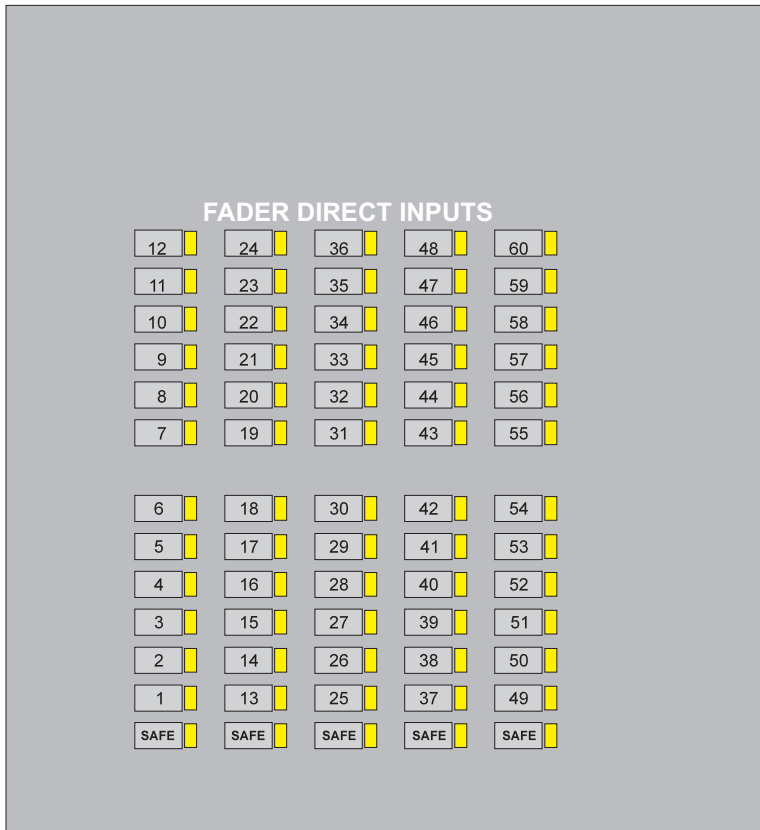

*Fader Direct Input Panel*

### To connect an input directly to a fader

- Press the Fader Direct push-button corresponding to the channel strip number.

The LED associated with the push-button will illuminate.

The signal previously routed through the channel strip will be switched out before the fader.

The direct input will be switched in before the fader, by-passing all the pre-fader signal processing elements.

### To prevent inputs from being changed

- Press the SAFE push-button beneath the corresponding channel number.

The LED associated with the push-button will illuminate.

All twelve channel push-buttons above the SAFE push-button will be fixed in their current state.

# VSP (Optional)

## Facilities

The VSP provides surround sound monitoring and recording facilities for the VRL Console.

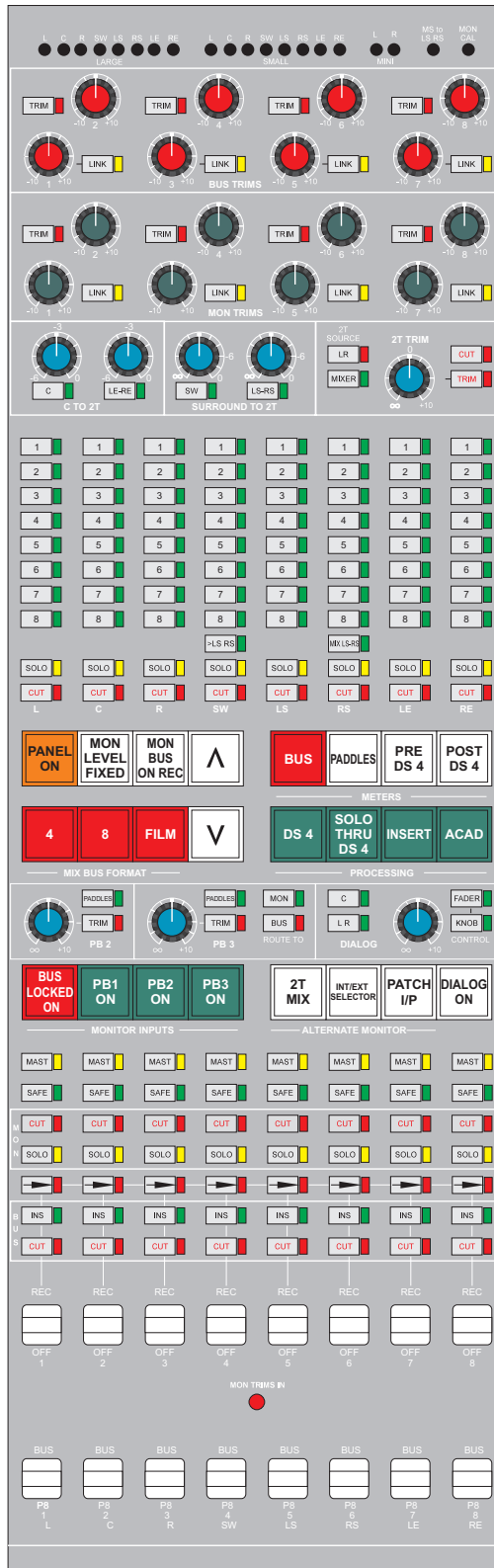

VSP Panel

## Panel ON

This switch configures the console for use as either a standard VRL Series console or as a scoring and post production console. In standard mode the console has the enhanced facilities of either 4, 6 or 8 mixdown busses. When PANEL ON is lit, the VSP is active.

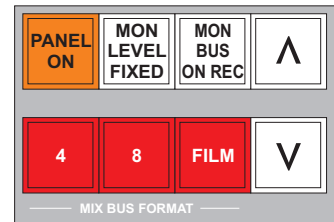

## 4, 8, Film Bus Modes

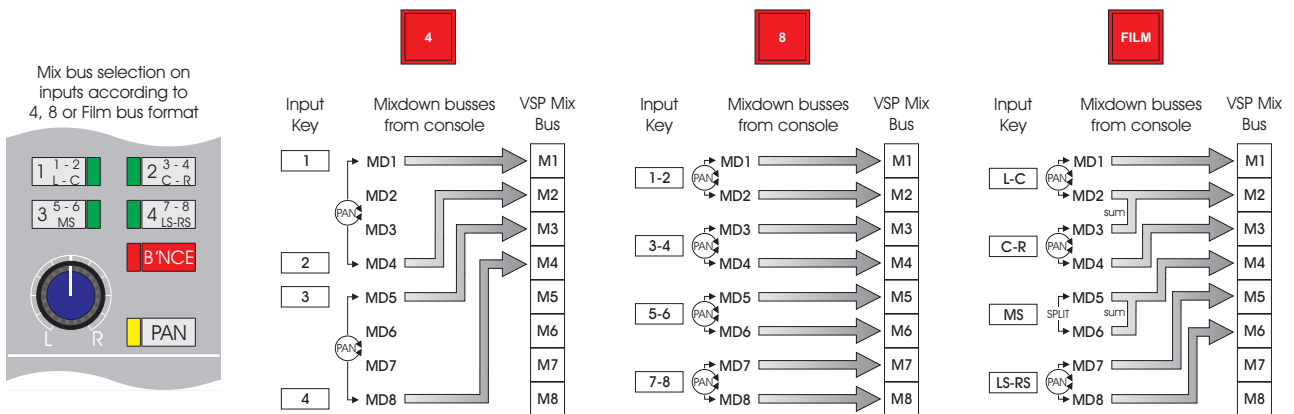

These keys configure the mixdown bus format of the console.

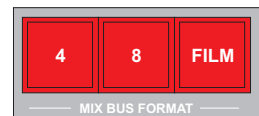

The 4 key selects the standard 4 mixdown busses. Inputs have left-right panning across 1-2 and 3-4.

The 8 key selects 4 stereo pairs of mixdown busses. The four mixdown routing push-buttons on the Inputs each select a stereo pair, with left-right panning across each pair.

The FILM key selects 3 stereo mixdown busses for left-centre, right-centre, rear surround panning, plus a mono surround bus (used for sub-woofer).

### Mix Bus Signal Flow

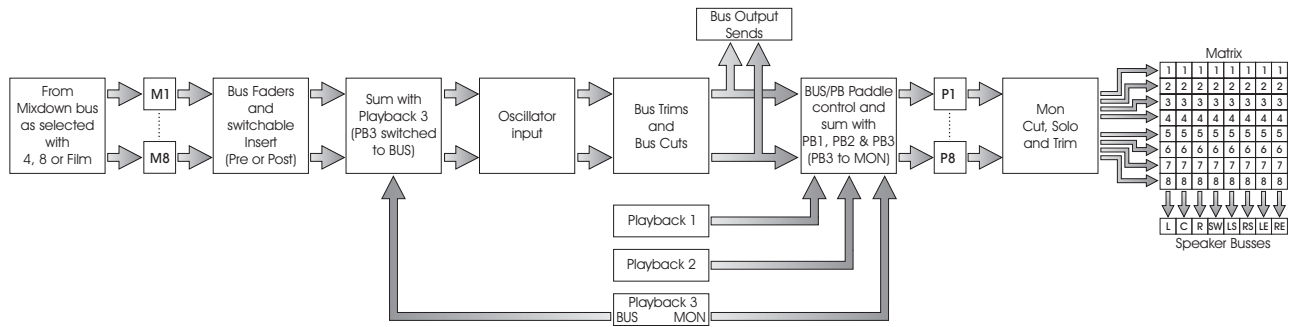

Summary of Mixdown Bus to Matrix signal flow in the VSP (from drawing EB11704)

Each bus has both a pre fade and post fade insert. Normal configuration for the desk is for the post fade insert to be always active and for the pre fade to be switchable by the INS push-button in the bus group of switches.

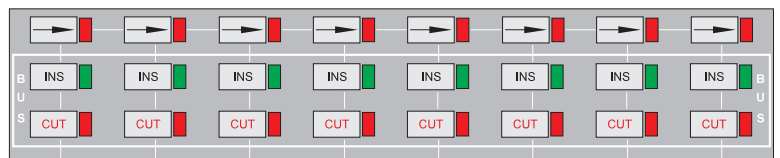

Below the INS push-button is the CUT push-button for the busses. Each bus may be cut as required. The INS and CUT switches are active in both STANDARD and VSP modes. (When the VR's recall is activated, the 8 mix busses are cut, but the cut LEDs do not illuminate).

At the top of the panel are the BUS TRIMS. Each bus has its own trim control. The control is activated by the TRIM push-button. Each bus may be trimmed by ±10dB. If a single control of a pair of busses is desired, the LINK push-button will cause the odd bus trim to control its adjacent bus, i.e. Trim 1 controls 1 & 2, etc. In this case, the bus trim for the even bus has no effect.

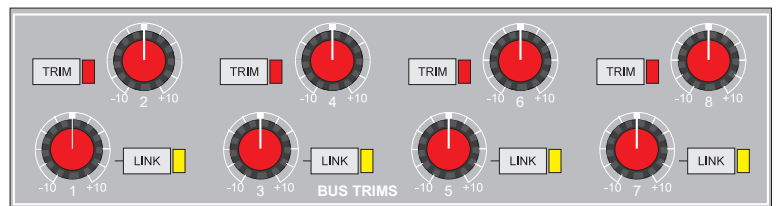

#### MON LEVEL FIXED

This activates a preset level for the feed to the speakers. The level is adjusted with the MON CAL trim pot at the top of the panel. When switched in, it overrides the level control pot (Control Room Monitor) or the optional music fader, whichever is active.

The Dialogue input is not affected.

MON LEVEL FIXED has no effect when PANEL ON is off.

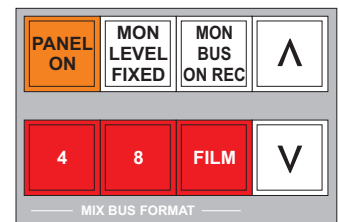

#### MON BUS ON REC

When activated, the system will monitor the BUS outputs when a channel is in record. If this switch is inactive, there will be no change on the input to the monitor when record states change.

### MATRIX and Speaker Busses

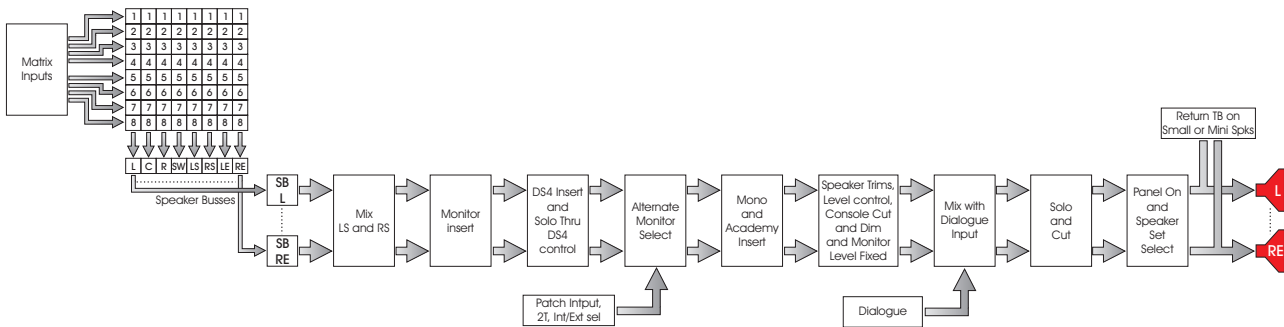

Summary of Speaker Bus signal flow in the VSP (from drawing EB11704)

The user selects which busses are sent to which loudspeaker (L, C, R, SW, LS, RS, LE, RE). The assignments are made via the 8x8 push-button matrix. The available busses depend on whether 4, 8 or FILM busses are selected. If 4 is selected then only busses 1 to 4 are available. All busses are available if 8 is selected. If FILM is selected then busses 1 to 6 are available.

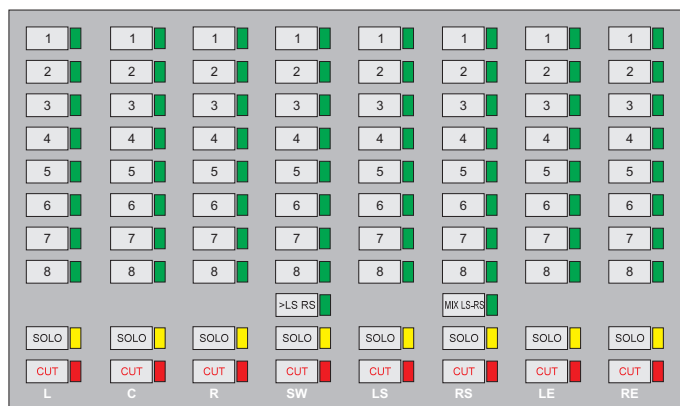

#### SOLO

SOLO will solo the individual speaker busses. It operates on the final output of the monitor paths and is not destructive to any 2T Mix selected from the monitor.

#### CUT

Cuts the output to the individual loudspeakers. The status of the cuts is remembered when an Alternate Monitor is selected. If the status of the cuts is changed while an Alternate Monitor is active, the cut status will be restored to the state before the Alternate Monitor was selected.

#### > LS RS

This replaces the post DS4 LS and RS signals with the post DS4 SW signal, allowing a post DS4 mono surround signal to be routed to stereo surround speakers.

#### MIX LS RS

Sums the LS and RS busses and outputs the sum to both the LS and RS speaker busses with a -3dB level adjustment.

## Metering

The VSP includes an extra meter bridge section of either VU or PPM moving coil meters. Each meter is labelled with speaker positions and bus numbers and has an LED to indicate what is being metered. The alphanumeric display is used to show status messages and for displaying software options.

In addition to this, the 2-Track Mix output can be selected for display on the regular 2-Track bargraph meters.

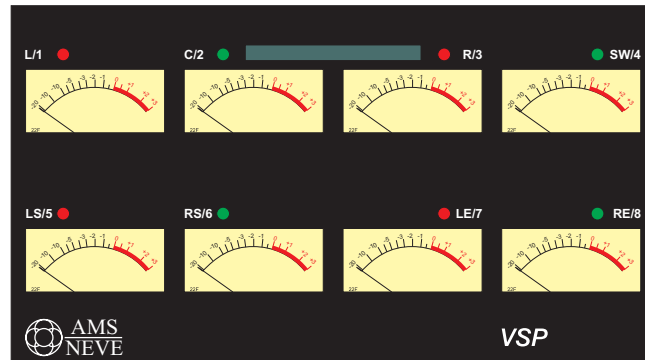

### BUS

When selected, the analogue VU meters will display the Bus output of the console via the Mix Bus to Monitor patch. When BUS is selected, the LED indicators for each meter will be illuminated red.

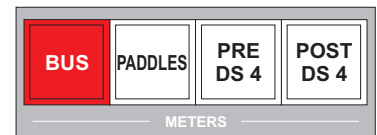

### PADDLES

When PADDLES is selected, the meters will display either Mix Bus or Play Back 1 to Monitor, depending on the state of the paddle.

When the paddle is green the LED for the relevant meter will be green to show the return is being metered and red when the paddle is not illuminated to show bus is being metered.

If the BUS LOCKED ON switch is on then the LEDs will illuminate yellow when the paddle is switched to PB to indicate that BUS and PB are being metered together.

### PRE DS4

Meters the signal before both the Insert and the DS4 insert patch points. The LEDs for each meter will be off.

### POST DS4

When POST DS4 is selected, the signal is metered post the DS4 insert patch. The LEDs for each meter will be off.

### 2T ON BARGRAPH

This key is in the Aux VU Meter section. When selected, the 2T Mix output from the VSP will be shown on the regular 2T bargraph meters.

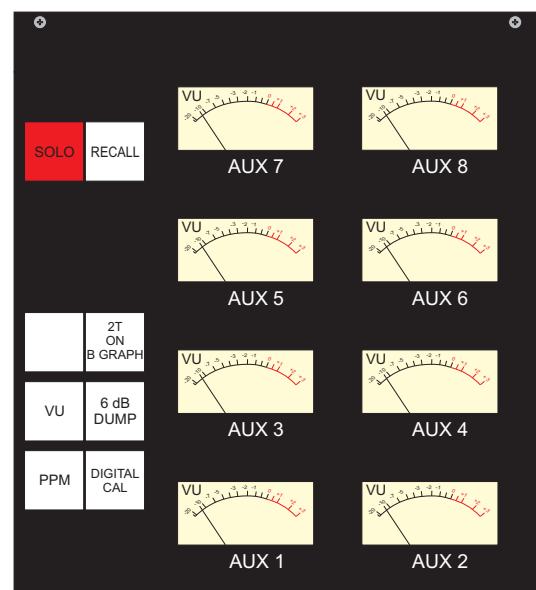

## Playback Control

### BUS LOCKED ON

When selected, the bus monitor signal is heard regardless of the state of the Bus/Return paddles. If the meter mode is PADDLES, the LEDs on the meters will be yellow in the return position to indicate that the bus signals are also being monitored.

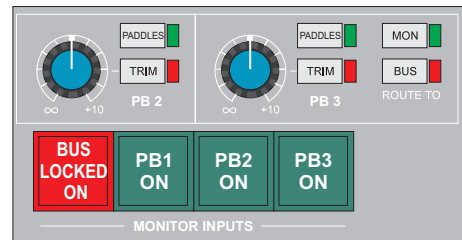

### PB 1 ON

When selected, the return side of the paddles is fed to the monitor. If the paddles are selecting Return and this switch is off, no signal will be heard.

### PB 2 ON

Selects PB 2 to the monitor. TRIM gives +10dB to OFF level adjustment. PADDLES forces the channel off when the paddle is selected to Bus and on when selected to Return.

### PB 3 ON

Selects PB 3 to the monitor or bus. BUS selects PB 3 to be mixed with the console mixdown busses after the post fade insert, but before the mix bus trims. PADDLES is defeated when BUS is selected.

## Options

Several of the functions on the following pages make use of the Options feature of the VSP. The Options feature allows additional functionality to be provided using software.

The Options feature is activated by pressing the up and down arrow keys on the VSP Panel at the same time.

The multi-character display for the Surround Meters will display 'SELECT A KEY'.

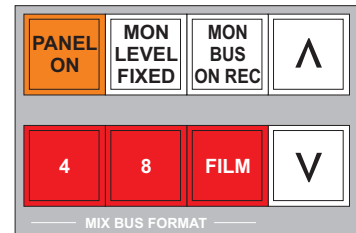

The next key pressed will determine the type of options that are activated. The options that can be selected are: ACAD filter type selection, Lock large speakers, 2 Track source selection, Mono routing, Group Insert Selection, a Software Hard Reset and Diagnostics Mode (see the relevant descriptions).

When in ACAD filter type selection, Lock large speakers, 2 Track source selection, Mono routing options or Group Insert Selection, it is possible to switch to another set of options by first de-selecting the current option (e.g. press the 2T MIX key to turn it off and then press the MONO key to go from 2 Track source selection to Mono routing).

The display will show 'SELECT A KEY' again when the active options are de-selected.

Exit from options mode by pressing the up and down arrow keys at the same time again.

## Inserts & Filters

### DS4

Inserts the DS4 into the circuit. The patch bay is configured as an active send on the upper row. If no DS4 is permanently installed or an external unit is not patched, selecting this button will cause the signal to disappear. If either a console channel or monitor, loudspeaker or bus SOLO is selected, the DS4 insert will drop out of the circuit. This may be overridden by:

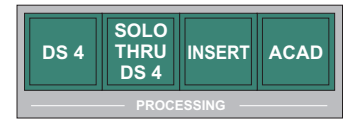

### **SOLO THRU DS4**

When selected, the DS4 insert will not drop out when a solo is activated. The switch is inactive when DS4 is off.

### INSERT

Selects the monitor insert path by activating the Speaker Bus return patch points. The send is always active with a switched and half normalised return on the lower row.

### ACAD

This switches on the Academy filter when MONO is active. ACAD can be switched on when MONO is off, but will remain dormant until MONO is switched on.

The ACAD patch is configured as a pre filter send with a half normalised return from the filter. This allows the user to use an external device in place of the internal filter. The filter can be configured for Standard, Small or Cascade modes via optional setups.

### **ACAD filter selection**

ACAD filter selection is possible from OPTIONS.

- Select OPTIONS by pressing the UP/DOWN keys simultaneously.

The multi-character meter display will show 'SELECT A KEY'.

- Press the ACAD key.

The ACAD key will flash to indicate ACAD filter selection mode and the display will show the currently selected ACAD mode, which will be 'ACAD Standard', 'ACAD small', or 'ACAD Cascade'.

- Press the UP/DOWN keys to select the required filter.

The display will scroll through the above filter types, each filter being switched in and out when the UP/DOWN key is pressed.

- Press either the ACAD key to exit ACAD filter selection mode and stay in options, or the UP/DOWN keys simultaneously to exit both ACAD filter selection mode and options mode.

## Dialog

### DIALOG ON

Selects monitoring of dialog.

**WARNING!** On the dialog control section, there are two buttons, FADER and KNOB. If neither of these push-buttons is selected, the dialog input is a line level input direct to the monitors. This can lead to very high levels.



(There is trim pot VR6 to adjust this. It is located in the Monitor Rack on the CVSUM Card (SXN823-042) in slot M38.)

To change the dialog level, select either FADER or KNOB. They are interlocked, but pushing the same push-button twice is a toggle. Use caution when operating these push-buttons.

Dialog can be routed to either C or L & R. C combines the left and right dialog inputs and sends the mix to the centre monitor. If the centre monitor is cut then the CUT push-button will be turned off so that the signal is heard.

## Alternate Monitor

### 2T MIX

Selects the output of the 2T Mix to the monitors.

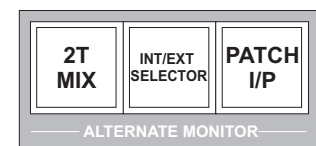

### INT/EXT SELECTOR

Selects the console internal / external selector to the left and right monitors.

### PATCH IP

Selects the patch input to the monitor.

## Monitor Speaker Set

The standard sets of speakers, Large, Small and Mini, are extended so that there are 8 speakers in the Large and Small sets, with only two (left and right) in the Mini set. The active set of speakers is selected from the Control Room Monitor with the LARGE, SMALL and MINI keys.

### Speaker Trims

The speaker trims are located at the top of the panel. The L trim operates as a master for each set and the individual trims give an offset from this for each speaker in each set.

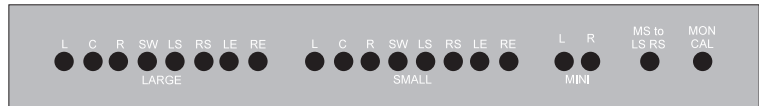

There is also a trim for MS to LS RS which trims the level used when MS is sent to both LS and RS for LCRS monitoring.

The MON CAL trim sets the overall speaker output level for when MON LEVEL FIXED is used.

### Return Talkback

If Return Talkback (RTB) is activated it will be sent to the Small or Mini speaker set. If the Large or Mini speaker set is currently selected for monitoring then Talkback will be sent to the Small speakers. If the Small speakers are selected for monitoring then Talkback will be sent to the Mini speakers.

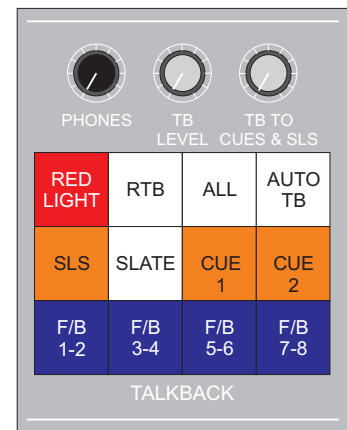

### Lock Large Speakers

Large Surround speakers (LS/RS) and Large Extra speakers (LE/RE) may be set to be permanently selected when the console speaker selection is set to Small (the corresponding Small speakers are cut). When (for example) LS/RS is locked to Large, Small speakers are selected and a VSP LS/RS speaker cut is switched in, the actual speaker cut will operate on the Large LS/RS. Small LS/RS will remain permanently cut.

This facility allows additional non-fitted control room monitors to be used as front Small speakers, while retaining surround monitoring via the Large Surrounds/Extras.

- Select OPTIONS by pressing the UP/DOWN keys simultaneously.

The multi-character meter display will show 'SELECT A KEY'.

- Press the MON LEVEL FIXED key.

The MON LEVEL FIXED key will flash to indicate Speaker Lock selection mode. The display will show the currently selected Large Speaker Lock which will be 'Lock Large LE/RE', 'Lock Large LS/RS', 'Lock Large Both' or 'Lock Large None'.

- Press up/down keys to select speaker locks.

The display will scroll through the above speaker locks, each lock being switched in and out when the up/down key is pressed.

- Press either the MON LEVEL FIXED key to exit Large Speaker Locks selection mode and stay in options, or the UP/DOWN keys simultaneously to exit both Large Speaker Locks selection mode and options mode.

The default speaker lock at power-up is Lock Large LS/RS.

**Talkback Dim**

If any talkback (except Return Talkback) is activated then the currently selected set of monitoring speakers will be dimmed by 20dB (set to -20dB as standard using preset pot VR1 on SXN823-042). The front panel variable dim control remains active (Control Room Monitor) so that the dim levels are cumulative. This only applies when PANEL ON is on.

**Studio Loudspeakers**

There are SLS outputs for Left, Centre and Right.

**External**

If EXT is selected then the external source for the standard monitor is sent to SLS Left and Right and Centre is cut. This is not affected by PANEL ON.

**Follow Monitor**

When the VSP is on and SLS is set to Follow Monitor then the SLS source is picked off post the Alternate Monitor Selector, unless AFL or PFL is selected on the console.

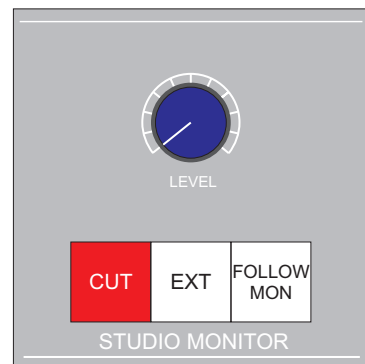

If no alternative sources are selected and AFL/PFL is off then Left, Centre and Right are sent to SLS Left, Centre and Right. When AFL/PFL is on then the SLS will switch automatically to the selected internal or external source as set on the Control Room Monitor. The Centre speaker is muted.

**2T MIX**

The 2-Track Mix is selected to SLS Left and Right and the Centre speaker is muted. If AFL is activated then the SLS will switch automatically to the selected internal or external source as set on the Control Room Monitor and the Centre speaker is muted.

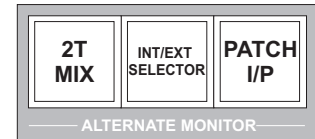

**PATCH**

Left, centre and right from the Patch Input is selected to SLS Left, Centre and Right. If AFL is activated then the SLS will switch automatically to the selected internal or external source as set on the Control Room Monitor and the Centre speaker is muted.

**INT/EXT**

The selected internal/external source for the standard monitor is sent to SLS Left and Right and Centre is cut.

**Talkback to SLS**

If talkback is selected to SLS then the normal program feed to SLS is dimmed by 10dB. This is not affected by PANEL ON.

## 2 Track Control

The 2T Mix can be either a simple combine of the active busses with odd busses to left and even busses to right or a user configurable mix from the monitor busses. The 2T Mix inputs go via patch insert points.

If a separate 2T fader is fitted, the TRIM allows the user to adjust the prefade insert level. If not fitted, then TRIM is the 2T master fader and prefade levels are fixed.

In standard mode, the 2T Mix outputs 1 & 2 are fed from the mix bus outputs 1 & 2. The 2T Mix outputs 3 & 4 are always fed from mix bus outputs 3 & 4.

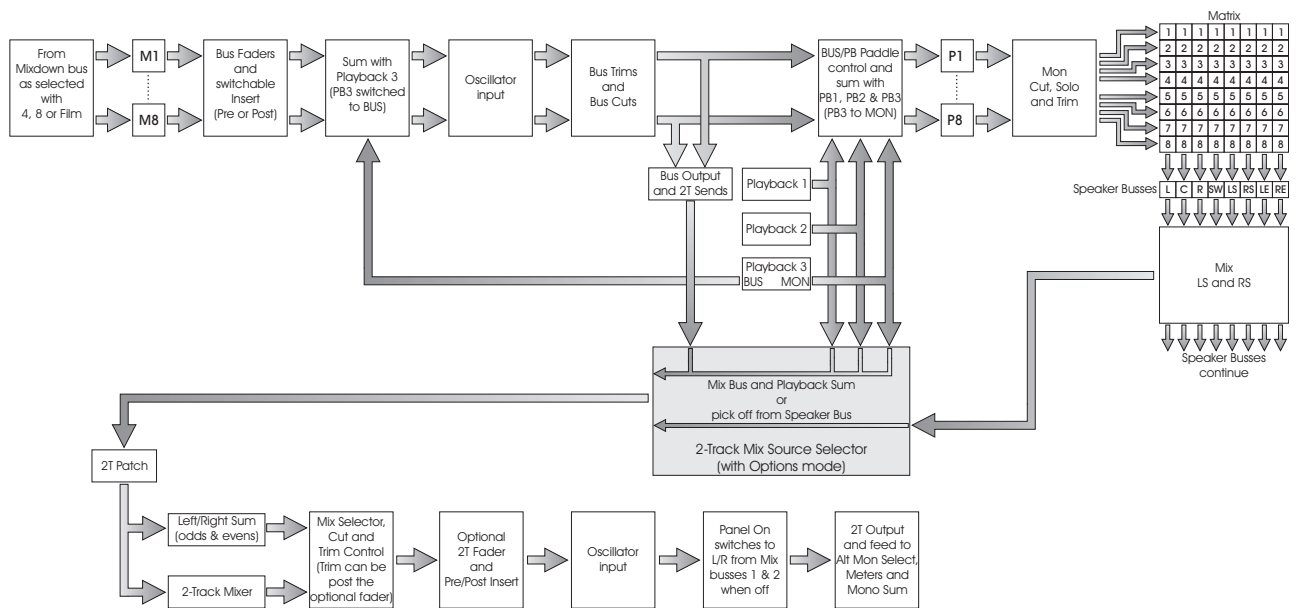

## 2 Track Mixing

### LR

When LR is selected, odd busses are fed to left and even busses are fed to right.



If 8 track bus format is selected then 0dBu on any two odd inputs will produce 0dBu on Left, and 0dBu on any two even inputs will produce 0dBu on Right.

If 4 track bus format is selected then 0dBu on either odd input will produce 0dBu on Left, and 0dBu on either even input will produce 0dBu on Right.

This assumes there is no trim in the circuit and the 2T fader is set to 0dB.

### MIXER

When MIXER is selected, the left speaker bus is fed to left, the right speaker bus is fed to right. Centre, Extra and Surrounds can be mixed in as desired by the user. The L Extra and R Extra channels are panned to mid way between L and C or C and R respectively.

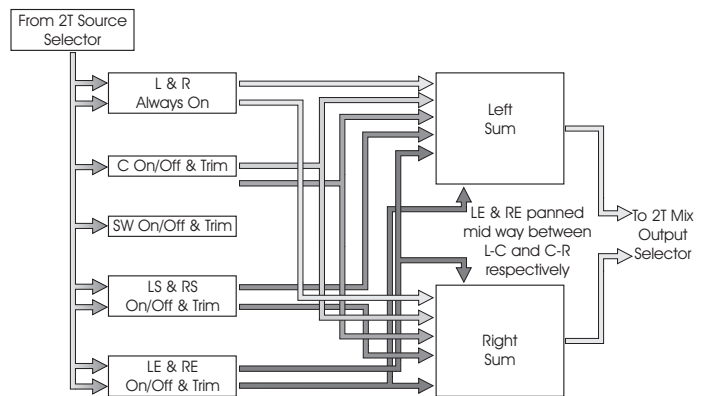

In order to illustrate how the mix is constructed, the following table shows the effect of 0dBu on each input (4 and 8 track bus formats):

Input (0dBu)	Left	Right
Left	0dBu	-
Centre (mixer level control at max)	0dBu	0dBu
Right	-	0dBu
Sub-Woofer to LS-RS (mixer level control at max)	0dBu	0dBu
Left Surround	0dBu	-
Right Surround	-	0dBu
Left Extra (LE-RE mixer level control at max)	-1dBu	-8.5dBu
Right Extra (LE-RE mixer level control at max)	-8.5dBu	-1dBu

This assumes there is no trim in the circuit and the 2T fader is set to 0dB.

## 2 Track Source

The 2T source can be selected from the mix bus (post the mix bus outputs), PB1, PB2, PB3 (or any combination of these 4) OR from the monitor path, post the matrix. PBs1-3 cannot be selected at the same time as the monitor path.

The default source is the monitor (speaker bus), picked off post the speaker matrix.

### To select the 2T sources

- ▶ Press the up and down arrow keys on the VSP Panel at the same time.

This activates options mode and the display on the surround meter bridge will show 'SELECT A KEY'.

- ▶ Press the 2T MIX key on the ALTERNATE MON selector.

The 2T MIX key will flash.

- ▶ Select BUS, PB1, PB2, PB3, in any combination using the BUS LOCKED ON, PB1 ON, PB2 ON, PB3 ON keys on the MONITOR INPUTS selector.

The selected keys will flash.

**or**

- ▶ De-select all the keys on the MONITOR INPUTS selector (no keys flashing).

This selects monitor, post the matrix, as the 2 track mix source.

- ▶ Press the up and down arrow keys on the VSP Panel at the same time to exit options.

 *If PB1, 2, or 3 has been selected the PB master must be switched on when 'options' has been exited, in order for that PB to be fed into the 2-track mix.*

Sources can be interrogated by activating the 2 Track options again and checking for flashing keys on the MONITOR INPUTS selector. No flashing keys on the MONITOR INPUTS selector indicates source from monitor, post the matrix.

When routed through MIXER, note that busses 1-8 or any of the PB 1-8 inputs will correspond as follows to the MIXER trim controls: 1-L, 2-C, 3-R, 4-SW, , 6-RS, 7-LE, 8-RE. Therefore inputs 1 and 3 cannot be trimmed individually.

## MONO Input/Output Routing

A mono mix can be made from any combination of monitor paths, and fed to any combination of loudspeakers. The input selection is made as follows:

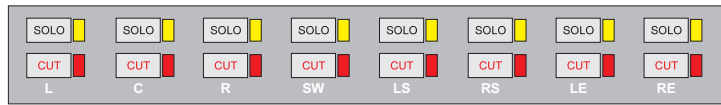

- Press the up and down arrow keys on the VSP Panel at the same time.

This activates options mode and the display on the surround meter bridge will show 'SELECT A KEY'.

- Press the MONO key on the Control Room Monitor.
- Press the loudspeaker SOLO push-buttons to select the monitor paths to be fed to the MONO bus.
- Exit from options by pressing the up and down arrow keys on the VSP Panel at the same time again.

The output selection can be set while in MONO, without the need to go into options, although it can also be made while in options at the same time as the 2 track input selection.

- Press the MONO key on the Control Room Monitor.
- Use the loudspeaker CUT buttons to mute the loudspeakers you do not wish to hear.

This loudspeaker selection will then be made every time MONO is switched on, and will be displayed by the CUT LEDs.

## Group Insert Selection

The group pre and post fade inserts can be configured in the options. They can be permanently out of circuit, switchable, or permanently in circuit, i.e. the status of the inserts can be dependent on, or independent of the bus insert switches.

The selection is made as follows:

- Press the up and down arrow keys on the VSP Panel at the same time.

This activates options mode and the display on the surround meter bridge will show 'SELECT A KEY'.

- Press one of the INS push-buttons in the BUS section of the VSP Panel.

The meter bridge display will show 'INS ON: PRE PST' and the LEDs for all 8 INS switches will flash to indicate selection mode.

'INS ON:' refers to the insert switch status and 'PRE PST' refers to which insert is actually active for that switch status. This display indicates that both pre and post fade inserts are enabled when the ins switch is ON.

- Press the up or down arrow keys to scroll through the active insert options (PRE, POST, PRE PST, or NONE).

Each of these will be the insert that is active for the displayed switch status and will be enabled as it appears on the display.

- Press the INS push-button again.

The display will show 'INS OFF: POST', which indicates that only the post fade inserts will be active when the INS switch is OFF.

- Press the up or down arrow keys to scroll through the active insert options (PRE, POST, PRE PST, or NONE).

Each of these will be the insert that is active for the displayed switch status and will be enabled as it appears on the display.

- Press the INS push-button a third time to return the display to 'SELECT A KEY'.

This is the equivalent of exiting the insert select option.

The settings can be checked by repeatedly pressing the INS button which will cause the display to show 'INS ON:', 'INS OFF:' and 'SELECT A KEY' in turn.

## Monitor Cut and Solo

### CUT

CUT kills the input of all the active inputs to the monitor for that particular Monitor channel.

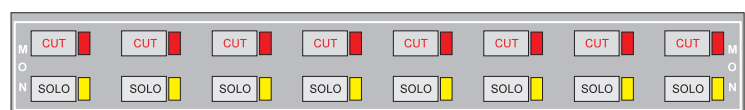

### SOLO

Solos the selected channel input to the monitor. It is a destructive solo in that any 2T Mix will be destroyed as all the other channels to the monitor are cut.

## Linked Controls and Switches

### MAST

If a Master Paddle module is fitted, any channel which has MAST selected will follow the state of the Master Record and Bus/Return Paddles.

### SAFE

When selected, the channel will not issue any record on commands. If record is active on a channel, a record off command will be issued and the channel will drop out of record.



When selected, ➔ links this column with the column to the right. The Bus Cut, Bus Insert and both Paddles are linked. Selecting any given control on either channel will cause the operation of the control in both channels. For example if channel 1 is in record, channel 2 is not and ➔ is pressed on channel 1, channel 2 will go into record. If ➔ is pressed on all channels, the link is deactivated. This provides a way to break an entire group of links without having to deselect them all.

### INS

INS activates the pre-fade insert return. The post-fade insert return is always active. This control is active in both VSP and STANDARD modes.

### CUT

Cuts the bus output of the console. Unlike the cut on a fader, this cut is a cut at the final output of the channel. This control is active in both VSP and STANDARD modes.

### REC/OFF Paddle Switch

This paddle activates the record controls for the VSP system. Pushing the paddle away from the user activates record. Pulling it towards the user cancels the record. This paddle will be illuminated red when a record is active and dark when not. The paddle is illuminated by a tally from the recorder. It will illuminate for approximately 50ms when a record is initiated. If no tally is returned, the paddle will go dark.

### BUS/TAPE Paddle Switch

This paddle activates monitoring the bus when pushed away from the user and monitoring Return when pulled toward the user. This paddle is illuminated green when monitoring Return and dark when monitoring Bus. (This paddle can be configured to monitor Bus, monitor Return or the state previous to record when a record is cancelled).

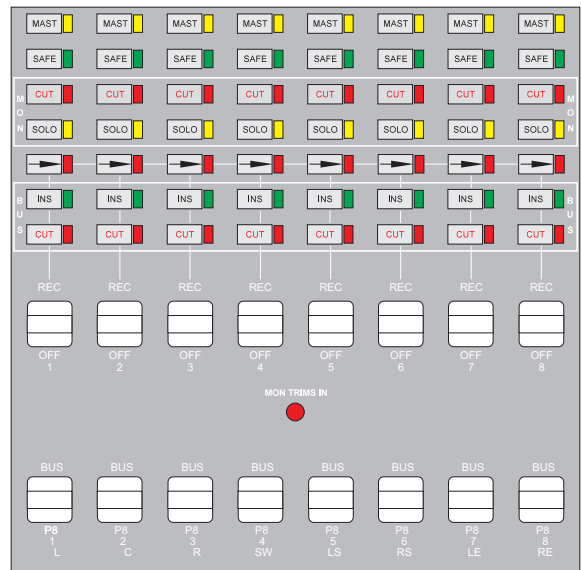

## Oscillator Override

The oscillator can replace the output on the VSP mix busses and the 2-Track Mix outputs.

### 8T 2T

The 8T 2T key causes the oscillator to replace the feeds to the 8 track (mix bus), 2 track and mono outputs.

If the oscillator is set to 0dBu then the output levels of the tone are 0dBu on the 8 track (mix bus) and 2 track outputs and +6dBu on the mono outputs.

The PANEL ON key has no effect on this function.

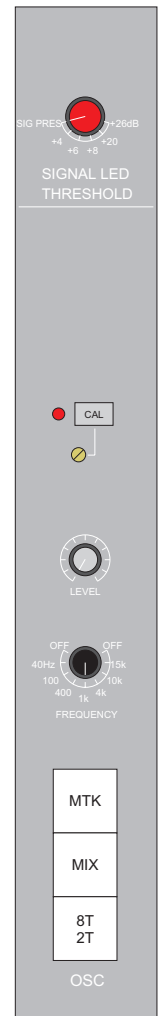

## Diagnostics Mode

- Press the up and down arrow keys on the VSP Panel at the same time.

This activates options mode and the display on the surround meter bridge will show 'SELECT A KEY'.

- Press and hold POST DS4, DIALOG ON, BUS LOCKED ON, and finally PANEL ON, in that order.

The CPU will reset and come up in diagnostics mode. The display will then show a hex value for all the digitally controlled switches on the panel, and any switches on the VR which are read by the VSP CPU (MONO, CUT, DIM etc.).

Both colours of LEDs on the surround meter bridge will flash sequentially from left to right and the console SOLO key (on the Aux Meter Panel) will flash.

- To exit from diagnostics press PANEL ON three times.

## Software Hard Reset

- Press the up and down arrow keys on the VSP Panel at the same time.

This activates options mode and the display on the surround meter bridge will show 'SELECT A KEY'.

- Press the PANEL ON key twice.

## RECALL

---

### Glossary

#### Automatic Scanning Mode

The automatic scanning mode scans the console three times and automatically identifies which (if any) channels need resetting. The scanning facility stops at the first channel which needs resetting, showing which panel needs resetting. The panel must be reset before the scan can continue. A particular block of channels can be selected for the scan via either the keyboard or the SOLO buttons. The monitor screen is not included in the automatic scan but can be selected for display. See HOLD MODE in this section.

#### Important

The automatic scanning mode only scans the channels and does not check the monitor controls. This means that the OK screen will appear when the channels only are correct. The master status buttons, if incorrect, will put the status flag on the channel screen to warn of this. This will only be displayed if the channel screen is called for resetting. Therefore it is recommended to always check the monitor setting. To select the screen use the S10 key.

#### Channel List

A record of primary and secondary channel use.

#### Colour Coding

A simple system of colour coding is used to assist the operator to reset the console controls. Controls which require resetting are displayed in their actual colours whilst those already reset are displayed in the grey background colour. When a control has been correctly reset, its colour on the screen automatically reverts to the background colour. LEDs and lamps are displayed in the (ON or OFF) state that they actually appear on the console. Some switches have associated LED-style indicators on the VDU screen to show their ON and OFF state even though no LED indicator is provided on the actual console, e.g. auxiliary PRE switches. Rotary controls and faders have their recall target positions displayed by pink (or magenta) spots or arrows, where a rotary control has a push/pull switch associated with it, e.g. the filter controls, the unreset foreground colour of the switch indicator is the same as the activating knob cap colour, so that the operator knows which control to set.

A colour code convention for the push/pull switch indicators is also used to indicate whether the control is on or off; red legends represent control on, whilst dark blue legends represent control off.

#### Console Mutes

During any on-line access to the console (during store and recall functions) the four-track mix post-fade outputs, the main cue outputs, the auxiliary outputs and the studio loudspeakers are muted. This is to eliminate any disturbances due to console scanning noise. The console mutes remain active for approximately five seconds after the store and recall functions have been cancelled. For consoles fitted with manual large faders it should be noted that the audio fader track is also used for Recall sensing and because this entails DC on the fader track, the audio signal is effectively muted during the store and recall operations.

#### Control Screens

Control Screens are actual screen images of the console control panels.

## Copy

This function is accessible under the HOLD MODE in recall. It allows the operator to copy the stored data of any channel onto the displayed recall screen of any other channel. The displayed channel can then be reset to correspond with the store of another channel.

Some uses of the copy function allow:

Channel positions to be exchanged for operational convenience.

Channel set-ups to be duplicated onto other channels.

Channel stores made on large consoles to be selectively reproduced on smaller consoles which do not have the desired channel numbers.

In the last situation, it must be noted that the large console stores, although unable to be directly recalled or presented without the use of the copy facility can be viewed in its entirety (See under View in this reference section).

Copy only manipulates the presentation of the stored information and will not alter or update the store database in any way. If the new console arrangement is required for subsequent recall, then a new store must be made of the final arrangement.

Copy only works on previously stored information and will not manipulate channel settings of the current console state, a store must be made first.

### **Access is by the copy key (in the recall hold mode)**

➤ Press COPY.

The following will be displayed:

'Enter channel number to be copied'

The channel number is entered via the keyboard and terminated with EXECUTE/RETURN.

Numbers up to a maximum of 96 can be entered and the system will read the selected store or display the message:

'Channel not stored' if no data is found.

This number may be larger than the number of channels in the present console if the store was originally made on a larger console, larger numbers or other invalid entries cause the copy function to be ignored.

A white flag appears on the already displayed target channel, to show that it's own store has been overwritten by the copied channel's store.

## Delete

Titles and stores can be deleted by highlighting the selected item with the cursor and pressing the DELETE key.

## Diagnostics

These are software routines provided to allow the studio engineer to verify parts of the recall system.

### **Hold Mode**

This is a static mode which presents the monitor screen on initial selection and then allows any other channel to be selected at will - either with the channel SOLO button or by keying in the channel number on the keyboard (See also Automatic Scanning Mode).

### **Keyboard**

The keyboard which is located in the monitor section of the console, forms the interface between the operator and the recall functions of the console.

### **List Store**

A function which lists, on a text screen, the stores made under a title.

### **Monitor Screen**

The monitor screen can be displayed at any time during the recall cycle by selecting the monitor key MON (S10). In Hold mode the monitor screen is the first displayed since it is very important to set up the master status controls before resetting any channels (see also Status Flag in this section).

To return to the channels in hold mode, simply select the next channel. To resume the scan in automatic scanning mode, press the SPACE-BAR.

### **OK Screen**

This screen appears at the end of an automatic scan if all the channels included in the scan have been reset correctly and the final check of three scans has been successfully completed.

### **Option Information**

The studio, artist, producer and engineer's names, entered from the top level menu, are designated as the option information.

### **Recall Timeout**

Recall function has a 45 minute timeout facility; that is after 45 minutes the system reverts to the list screen. Resetting of the console can be continued simply by re-selecting the recall function.

### **Record Active Flag**

If the multitrack and two track/four track master tape machines have their record tallies connected to the console and the operator attempts to make or recall a store when either of the machines are in the record state, the RECORD ACTIVE flag is displayed, with the prompt line PRESS ANY KEY TO QUIT. Access to the on-line console functions store and recall is inhibited. Pressing any key takes you back to the List menu.

The reason for inhibiting access to the on-line functions is that they activate the console scanning system which creates some low level noise (buzz) which could be recorded onto the tape. (It is therefore advisable to use the record tallies to prevent this happening.)

### Reset Cancelled Screen

This screen is displayed if the Automatic Scanning Mode is cancelled. The following message is displayed:

‘Final Check Not Complete’

At this stage an inspection can be made of the console which will show solo lamps illuminated on the scan start and stop channels and also on any channels which have either been skipped, or were not included in the original store.

The screen prompts ‘Press Any Key to Continue’ any key pressed will return to the list (stores) menu.

### Reset Flag

The reset flag is a large yellow flag displayed on the channel or monitor screens indicating that all of the controls displayed have been reset to their stored positions. Note that this flag applies only to the particular screen that is currently displayed, so that if a reset flag appears on a zoomed-in screen for example the equaliser section, it means, that, only that section has been reset rather than the whole channel.

### Skip

This is used in the automatic scanning mode to allow channels which may not be required in the scan to be skipped or by-passed.

There can be a variety of reasons for wishing to skip a channel; it may not be required in the recall set-up, it may have been removed from the console for maintenance, or there may be a fault on part of its Recall sensing which could prevent the scan from continuing. Whatever the reason, skip gives an easy way of avoiding the problem.

Another use of skip is to resume the automatic scanning of the console channels after the monitor screen has been displayed.

The Key used for skip (in auto mode) is the space-bar.

Once a channel has been skipped, the scan will resume at the next channel and because the system always attempts to check the recall by running the scan on the reset section three times, it will continually return to the skipped channels.

To exit the scan at this stage, the cancel key must be used and the ‘Reset Cancelled Screen’ will be shown.

### Status Flag

The status flag is a large red flag displayed on the channel module screens when the console master status controls, e.g. master mic, master fader swap, are not correctly reset to the store positions. It is essential for the correct functioning of the channels that the stored setting of the master status controls are reset first. Therefore, if the status flag is displayed, the monitor should be reselected and the status controls reset. If this action is required because the switches have been accidentally pressed, then it will be necessary to recheck the functions on any previously reset channels; this is because the master status controls overwrite the channel settings.

**Store**

A block of data comprising a selected configuration of console control settings.

Associating text notes with a store:

**Store - Creating**

Storing a selected configuration of console control settings.

**Store - Naming**

Associating a name with a newly created store.

**Store - Recalling**

Recalling a selected store with the option of resetting the console.

**Store - Renaming**

Renaming a previously created store.

**Store - Viewing**

Displaying a selected store.

**Text Screens**

Text Screens are text based screens used to display and manipulate record keeping information.

**Title**

A title is any convenient sub-division of a recording session, which can be given a name and allocated a number. A title provides a heading and location for one or more stores.

**View Channel List**

Viewing the record of primary and secondary channel use associated with a particular title.

**View Screens**

The view screen displays are similar to the recall displays; monitor, full channel and zoomed sections are all available in the same way. The screen shows positions of switches and rotary controls and use LED indicators and colour coding for off and on switch functions in the same way as the recall screen. Because view is off-line and therefore not interactive with the console, the displays and therefore the controls are given in full colour, effectively showing a photographic view of the console controls at the time of the store.

**Zoom**

The zoom function which is available in both store and recall, allows sections of the channel module to be displayed in an enlarged form. Zooming can be used to advantage if, for example only the equaliser sections are required to be reset. It is a useful facility should the operator prefer to reset the console a particular section at a time or if the enlarged display is preferred. To zoom in to a particular panel, the selected target area key (S1 to S5) should be used. To zoom out (to the full channel display) the ALL (S6) should be used.

### Zoom Keys

The zoom keys are used to select the console panel to be displayed in its enlarged format.

The keys available are given below:

Channel Section	Function Key	Label
Routing	S1	RTE
Input and Dynamics	S2	I/P & DYN
Auxiliary	S3	AUX
Equaliser	S4	EQ
Mini Fader	S5	MN FDR
All	S6	ALL

To zoom in to a particular panel, the selected target area key (S1 to S5) should be used.

To zoom out (to the full channel display) the ALL should be used.

### Zoom Screens

A zoom screen is an enlarged display of one of the channel sections available in both store and recall modes.

## Introduction

The Neve Recall System is an optional addition to the Neve VR consoles. All VR consoles are supplied ready to accept the AT compatible computer, high resolution VGA colour graphic display and Neve VR Software which enable storage and Recall of rotary pushbutton and fader controls. The system may be used in either automatic or individual channel mode and has been designed with the emphasis on ease and speed of operation, with crystal clear full colour graphics and many unique features.

This allows you to return to a project later in the confidence that you can immediately re-create the sound, even in a different studio; it allows studios to interleave jobs.

The recall system is automatically available at switch-on unless Flying Faders are fitted, in which case Recall is invoked by selecting Recall on the Flying Faders system menu.

The Neve Recall System is made easy to use for the novice by displaying most of the available operations at the top of the screens and a comprehensive system of prompts and messages at the bottom of the screen. Moving down through the system structure requires the correct function key to be pressed or a prompt line instruction to be followed. Most alpha/numeric entries are entered with EXECUTE/RETURN. Returning to a higher level if not automatic, is achieved by using the CANCEL.

## Installation

Please refer to the Installation manual for details of the installation procedure. This must be done by an AMS Neve Technical Service Engineer or by the Studio Technical Engineer.





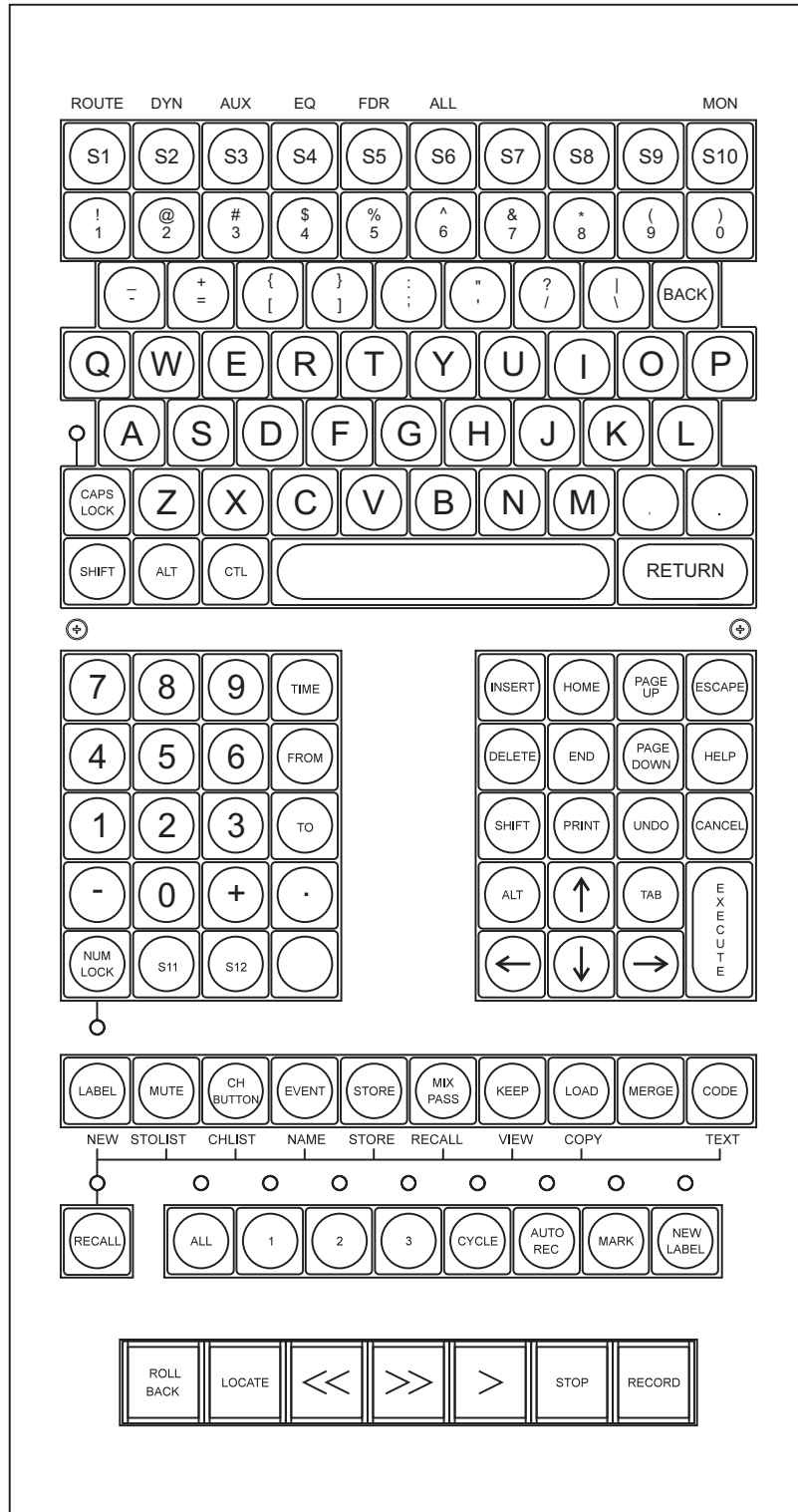





## The Keyboard

The Neve Recall System is operated by the alphanumeric keyboard located in the monitor section and viewed via a VDU. (Where Flying Faders are fitted the control equipment is common). The keyboard is based around a standard QWERTY keyboard layout with a number of additional function keys as shown below. The specific operation of the keys is described opposite.

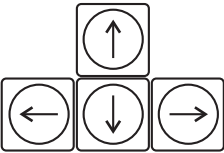
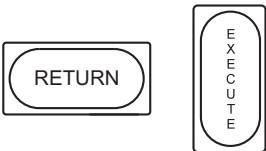

RECALL KEYBOARD LAYOUT

### Key Functions

<p>ROUTE</p> 	<p>Display 'zoom' keys or selective storing keys</p>
<p>DYN</p> 	
<p>AUX</p> 	
<p>EQ</p> 	
<p>FDR</p> 	
<p>MON</p> 	<p>Zoom key only.</p>
	<p>Selects opposite case for letters and upper character of two character keys.</p>
	<p>Cursor moving keys.</p>
	<p>(Pressing these has the same effect).</p>
	<p>Cancels a command and moves up to a previous screen in the menu tree.</p>
	<p>Copies channel information to other channels used if the console has been cross patched.</p>
	<p>Exits Recall if pressed at top level menu with no list showing.</p>

**Key Functions continued**

Toggles between insert and overwrite mode during text entry.



Deletes highlighted character during text entry or store/title highlighted.

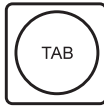

In top level menu selects client and project lists.  
In other menus it is used to select fields.



Enters store list of highlighted title.

STOLIST



Used to make new title, client etc.

NEW

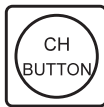

Displays Flying Fader channel name list.  
Shift+ key displays/exits Recall primary and secondary channel lists.

CHLIST



Allows a store or title to be named.

NAME



Takes a store of console.

STORE



Recalls a store of console setting.

RECALL



Allows store to be viewed without scanning console.

VIEW

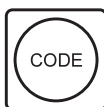

Used to start a text entry for a store or title.

TEXT

## Screens

### Text Screens

Text screens are used to manipulate record keeping information. They are edited using the alphanumeric keyboard. Text screens are used to record information such as:

Channel Allocation

Session Details

Client Name

Project Name

Studio Name

Track Information

Console layout

Text screens can be accessed through the Top Level Menu by pressing TEXT. An area at the bottom of the screen will be displayed with a flashing red cursor. This area can be used for storing information (text) which may be essential for the operator to know.

### Control Screens

Control screens are representations of the console control panels; i.e. input/output channels and monitor panel. Colours are extensively used in this mode and interaction is both through the alpha-numeric keyboard and the control themselves. Depending upon the operational mode, they may be either static displays or dynamically interactive with the actual controls.

The control screens are an exact representation of the console control surface. Mode and display control information are presented in a text box at the bottom of the screen.

### Hidden Access Commands

These are accessed from the top level menu but are not shown on the top line. They are not intended for use by Clients and are commands for which it is advisable for the studio to provide supervision to avoid loss of data.

## Disk Commands

### (Control D) The disk Commands or Access Command

The disk commands are used to back-up and restore recall data to and from floppy disk. disk commands are invoked by highlighting the required function with the cursor (using the arrow keys) and pressing EXECUTE/RETURN. To return to the top level menu, press CANCEL. If a floppy disk is not present, or, for some commands, the disk is not formatted, the system will return an error message and the prompt:

[Abort, Retry, Fail?]

► Press the appropriate first letter in response (i.e. A, R, F), followed by EXECUTE/RETURN.

The disk commands screen will be displayed.

Disk commands	S10 (save)	Cancel (quit)	
Neve Demo Studio			
Client:	Escape Committee		Date Created:
Project:	Recall Project		Today's Date:
			Current Time:
1. Show floppy disk contents 2. Check floppy 3. Format floppy disk 4. Prepare floppy disk for recall backup 5. Backup to floppy disk 6. Restore floppy disk to hard disk			
Select command: Exec / Cancel			

If during disk operations the recall system fails, the system may return to either the Flying Faders system if operational or the DOS system if Flying Faders are not fitted. From Flying Faders all that is necessary is to reselect the recall system from the System menu and continue. From the DOS prompt, the command Recall should be entered and Execute/Return pressed.

### Show Floppy Disk Contents

This command lists the stores (or files) and directories held on the floppy disk currently in the disk drive, position the cursor and press EXECUTE/RETURN.

### Check Floppy Disk

This function looks at the disk and checks that all the disk sectors are O.K. Position the cursor and press EXECUTE/RETURN.

### Format Floppy Disk

This function arranges the storage areas and indexing on a blank disk into the necessary format. A good quality double-sided, high-density 3 1/2" disk (usually denoted 3.5, DS, HD) must be used for the 1.4 Mb format used in this system.

**WARNING** Do not attempt to reformat a disk which already has data written on it as this will result in total loss of all data on the disk. No warning is given if the disk to be formatted already contains files.

It is recommended in cases of doubt that the disk contents are checked using the 'Check Floppy Disk' command before any attempt is made to format the disk.

- Position the cursor and press EXECUTE/RETURN.
- Press N and EXECUTE/RETURN.

The screen returns to the disk commands and formatting is complete.

To protect against overwriting existing data, place a write protect tab over any disk which contains files and label the disk correctly.

 A disk formatted under Flying Faders is suitable for use here and vice versa.

### Prepare Floppy disk for Recall Backup

This is necessary to enable the recall data to be stored on the floppy disk. It arranges the information storage in such a way that the same disk can be used for Flying Faders and recall data without risk of mutual erasure.

- Position the cursor and press EXECUTE/RETURN.

The following message will appear:

'disk prepared'

- Press any key to continue.

### Backup to Floppy Disk

This function copies all the recall data which has been created (and therefore stored on the hard disk) to the floppy disk.

- Position the cursor and press EXECUTE/RETURN.

The following message will be displayed:

<p><b><u>Warning</u></b></p> <p><b>Existing Recall data on this Floppy disk will be destroyed</b></p>
<p><b>Press Y to backup selected project</b></p> <p><b>Press N to exit</b></p>

- See Warning and select command.

### Restore Floppy disk to hard disk

This function allows the recall data on a back-up floppy disk to be restored to the system. The floppy disk need not have been written in the same studio.

**Warning**

In order to restore the information from the floppy disk, the hard disk target area must be cleared. This means that all the recall information presently on the system, for that particular client and project, must be erased. This action is performed automatically but to prevent accidental erasure, a warning screen is displayed and two positive decisions are required before the data erasure and subsequent floppy disk restore can proceed.

If the hard disk information needs to be retained it must be backed-up BEFORE using the restore function.

This function can also be used to remove all the recall data from the hard disk, if required. The procedure is carried out in the normal way but without a floppy disk in the system.

➤ Position the cursor and press EXECUTE/RETURN.

The following will be displayed:

<b>Please Wait</b>  <b>Project titles and stores being restored from disk.</b>
<b>Warning!</b>  <b>Client:</b> <b>Project:</b>  <b>Do you wish to load this project?</b>
<b>Press Y to load N to terminate</b>

**Diagnostics**

Please refer to the Installation Manual for this information.

**Set-up Procedure**

Please refer to the Installation Manual for this information.

## **GUIDED TOUR OF RECALL**

---

### **Introduction**

The VR Recall system operates from the same computer as Flying Faders and there is a degree of interaction between the two systems, in particular the client, project, title hierarchy and channel ID is automatically copied from Flying Faders to Recall.

Control of Recall is via the console's keyboard where certain keys operate as dual function shared between the two systems. It is not possible to address the Recall System from the mouse/trackball, instead the cursor is controlled via the arrow keys. There are two types of screen: Text and Control. The Text screens are used to command and display the system's operation and the Control screens are graphic representations of the console. The basic operation is very simple but there are additional more complex functions available.

As many as 999 stores can be kept per title, each will carry a number, an optional name, the date it was created and many lines of user text, four of which may be displayed at any one time. A store can comprise the entire console or just pre-defined areas, for example channels 10 to 30 only, or EQ section only. It takes only 2.5 seconds for the computer to scan through a 60-channel console and record all the controls. In addition, channel (primary) and small fader (secondary) ID information can be saved in a Channel List. Data can be stored on hard and floppy disks where they will be filed under the appropriate Client.

### **Delete Function**

The DELETE function is designed to operate from all hierarchical levels, that is DELETE can be implemented from the CLIENT, PROJECT, TITLE or STORE level. All data under the selected level is then deleted from the system.

### **Cancel Function**

The CANCEL function is also designed to be operated from all hierarchical levels, cancelling functions which may have been undertaken in error or returning to a previous level in the menu system.

## Getting Started

### Getting into Recall from Flying Faders

- Press RECALL

Lets now move into the screens, their functions and the necessary keystrokes in order to access the functions.

## Top Level Menu

### To Fill in Title Header

#### To Access Title Header from the Top Level Menu

- Press ^O (hold down the CTRL key while pressing O).

A prompt will appear: Enter Studio Name

- Type in name and press EXECUTE/RETURN to skip to next field.

If a mistake is made before EXECUTE/RETURN has been pressed then pressing CANCEL will return to the Top Level Menu. If you wish to change or edit the Studio Name then re-start from ^O.

### Title

#### To create a new title

- Press NEW.

A prompt will appear: NEW TITLE:

- Press ENTER/NAME/CANCEL.
- Press EXECUTE/RETURN completed with default name.

**or**

- Press NAME - Enter name at keyboard and EXECUTE/RETURN.

**or**

- Press CANCEL.

This ends title creation.

## Client/Project/Title Structure and Editing

In a similar way to Flying Faders, store data can be stored under the additional levels of hierarchy. The highest of these levels is CLIENT; under each CLIENT there can be several PROJECTS and under each PROJECT there can be several TITLES.

CLIENT and PROJECT lists are displayed in an additional window which is displayed in the top level (titles) menu when required. When selected the CLIENT and PROJECT names are displayed in the main screen information.

- Press TAB

The Client List will be displayed.

- Press TAB again.

The Project List will be displayed.

### To create new Client or Project Headers

- Select the Client or Project list as previously described.

At the bottom of the screen a box will be displayed:

<b>Select Project:</b> <b>New/Exec/Name/Tab/Cancel</b>
--

- Press NEW followed by NAME.

The cursor will flash in the Client box.

- Key in the name of the new Client and press EXECUTE/RETURN.

The name of the new Client will now be displayed and the Project List will automatically be displayed. To edit the Project List, follow the same procedure as the Client List.

## To Fill in Channel List

### Select Title

- Press the CURSOR ARROW KEYS to highlight the required title.

### Open Channel List

- Press SHIFT key and CHLIST.

The default channel list is displayed.

- Select the channel using the CURSOR ARROW KEYS.
- Select the channel (primary or secondary) to be named.

To move between primary and secondary channels

- Press CTRL → or CTRL ← .
- Enter name by pressing NAME then EXECUTE/RETURN.

Carry on editing by moving around using the cursor arrow keys and naming selected channels. When editing is finished

- Press S10 to save or CANCEL to end, without saving changes.

Return to Top Level Menu.

- Press CANCEL.

### Creating Text and Editing

You will see on the right hand side of the Top Level Menu screen is a Text heading. This allows the operator to make notes on the highlighted Title and Name.

#### To Access the Text Column

- Press TEXT.

At the bottom of the screen a text window will appear, with the cursor flashing. You are now able to enter text for the selected Title.



*Please note that pressing EXECUTE/RETURN saves the text on to the hard disk and does not move the cursor to a new line.*

Situated on the right hand side of the screen, underneath the Text heading, you will see the word **YES** displayed to signify that the text has been entered.

#### To View Existing Text

If you wish to view the text on any given Title

- Highlight the title and press the Text button.

The text window will appear at the bottom of the screen. To exit without modifying the text

- Press CANCEL

#### To Edit Existing Text

Select the Title and proceed as previously described. When the text window is displayed

- Press NAME.

The flashing cursor is displayed at the end of any existing text and may now be modified. When editing is finished

- Press EXECUTE/RETURN to save the changes.

Pressing CANCEL will give the option to exit without saving or to save the changes.

## Open Store List

- Press STOLIST

### To Make a Store

The complete console can be stored or, alternatively, individual channels or sections such as Eq or Aux can be stored. When making or recalling a store, please note that the whole desk output is muted.

- Press STORE

Unless the **Record Active Flag** is displayed the following procedure should be followed:

A prompt will appear: NEW STORE: EXEC/RETURN/NAME/S1-S6/CANCEL

For total console store

- Press EXECUTE/RETURN completed with the default name.

**or**

- Press NAME (enter name at keyboard).

- Press EXECUTE/RETURN.

**or**

- Press CANCEL which terminates the store creation.

### Selective Store

#### Sections

- Press STORE.

To store a specific section of the console for example routing, dynamics etc.

- Press S1-S6 as displayed at the top of the screen.

For example, if you wish to store the routing section

- Select S1 and press EXECUTE/RETURN.
- Press EXECUTE/RETURN again to store routing section for all channels or press the Solo buttons on the console channel strips for specific channels. Confirm selection by pressing EXECUTE/RETURN.

#### Channels

To store all the settings for a specific channel

- Press S6 for all as above.
- Press EXECUTE/RETURN and select the required channel(s) via its Solo button.
- Press EXECUTE/RETURN to confirm selection.

### To Recall a Store

Data can be selectively stored at the PROJECT level. Once a PROJECT and the TITLES and STORES made under it have been selected accessing the disk facilities and saving the store to a floppy will store all the TITLES and STORES under that PROJECT.

- Select a Title by using the cursor arrow keys to highlight the required title.
- Press STOLIST to open the Store List.
- Select a Store by using the cursor arrow keys to highlight the required Store.
- Press RECALL (Mix Pass function key).

### Hold

- Press H.

An Interactive Monitor Screen will be displayed.

The knobs and switches which are incorrectly set will be illuminated on the screen with their cap colour for easy identification. Depressing the switch or rotating the knob until its pointer aligns with the pink dot on the screen will correctly reset the control. When all controls are correctly reset a yellow RESET flag will be displayed at the bottom of the screen.

- Enter the channel number or cancel.
- Select channels using SOLO or Numeric Keys.

An Interactive Monitor Screen will be displayed.

- Reset channel module settings as described previously.

A red STATUS flag illuminated at the bottom of the screen, indicates that the Monitor Section STATUS buttons are incorrectly set.

### Next chan,

To Select a new channel

- Enter its number on the numeric keypad and
- Press EXECUTE/RETURN or press the SOLO key.

### Zooms

Zoom allows the operator to view a specific section of the channel module on the screen e.g. Routing, Auxiliary etc.

- Select S1-S5.

To return to normal viewing

- Press S6.

### Mon

To select a view of the Monitor section

- Press S10.

## Copy

To copy the settings of one channel module to another

- Press COPY.

Enter the channel number to be copied by the numeric keypad and

- Press EXECUTE/RETURN.

Enter the number of the channel you require it to be copied to and

- Press EXECUTE/RETURN.

This channel may now be altered to match the copied settings. The copied channel will be displayed on the channel which is being edited.

Individual sections (e.g. EQ section) may be copied from one channel to another, using the S1-S5 keys.

 Please note that the new settings for this channel will not be stored until a new store is made.

## Auto

### To select a Title

- Use the cursor arrow keys to highlight the required Title.

### To open a List

- Press STOLIST.

### To select a Store

- Use the cursor arrow keys to highlight the required Store.
- Press RECALL (Mix Pass function key).
- Press A for Auto.

A prompt will appear:

[Start=1 Stop=n, Exec/Return/Select Channel/Cancel]

- Press EXECUTE/RETURN for complete console channel scan.
- Reset the interactive channel screens as they are displayed.

Wait for final check and the OK screen.

**Selected Channels Only**

When only a specific range of channels need to be scanned. Set Recall into Auto mode as above.

A prompt will appear: [Start=1 Stop=n, Exec/Return/Select Channel/Cancel]

➤ Enter the Start Channel number using the numeric keypad and press EXECUTE/RETURN.

Enter the Stop Channel number in the same way or via the Solo button on the Channel Module.

➤ Reset the interactive channel screens as they are displayed.

Wait for final check and the OK screen.

To return to the Top Level Menu

➤ Press CANCEL twice.

## Index

---

- 2 Track Control . . . . . 9:11 - 9:13
- 2 Track Source . . . . . 9:13
- 2:1 ratio expander . . . . . 7:3
- 2T meters . . . . . 3:11
- 2T Mix . . . . . 9:8
- 48-track routing . . . . . 4:1 - 4:2
- 4-track routing matrix . . . . . 3:7
- 6dB dump on VU bargraphs . . . . . 6:1
  
- Academy filter . . . . . 9:7
- Adjust mono aux send levels . . . . . 4:4
- AFL solo . . . . . 4:11
- AFL, glossary entry . . . . . 1:1
- Alternate Monitor . . . . . 9:8
- Attack time . . . . . 7:6
- Audio grouping, glossary entry . . . . . 1:1
- Auto . . . . . 10:21
- Auto match . . . . . 3:8
- Automatic Scanning Mode . . . . . 10:1
- Aux master balance . . . . . 5:2
- Aux master level controls . . . . . 5:2
- Aux meters . . . . . 6:6
- Aux pre-fader . . . . . 4:4
- Aux send levels . . . . . 4:4
- Aux sends . . . . . 4:4
- Auxiliaries . . . . . 3:4
- Auxiliaries pairs to the monitor path . . . . . 4:5
- Auxiliary Master Panel . . . . . 3:16
- Auxiliary master section . . . . . 5:2
- Auxiliary meters . . . . . 3:19
- Auxiliary section . . . . . 4:4 - 4:5
  
- Backup to Floppy Disk . . . . . 10:13
- Bounce, glossary entry . . . . . 1:2
- Broadcast . . . . . 5:7
- Broadcast mode, introduction . . . . . 2:16
- Bus, glossary entry . . . . . 1:2
  
- Calibrated oscillator level . . . . . 5:1
- Calibration level . . . . . 5:1
- Cancel all current solos . . . . . 4:11
- Cancel Function . . . . . 10:15
- Channel fader select . . . . . 3:8
- Channel faders . . . . . 3:8
- Channel List . . . . . 10:1
- Channel processing . . . . . 7:1
- Channel status . . . . . 3:6
- Channel strip . . . . . 3:2 - 3:7
- Channel, glossary entry . . . . . 1:2
- Channels . . . . . 10:19
  
- Check Floppy Disk . . . . . 10:12
- Client . . . . . 10:17
- Clipping, glossary entry . . . . . 1:2
- Colour Coding . . . . . 10:1
- Combine the monitor and channel  
  solo systems . . . . . 4:11
- Comms, glossary entry . . . . . 1:2
- Compression ratio . . . . . 7:6
- Compressor . . . . . 7:5 - 7:6
- Console Mutes . . . . . 10:1
- Console status configuration . . . . . 3:12
- Console surface . . . . . 3:1 - 3:20
- Control grouping, glossary entry . . . . . 1:2
- Control room monitor . . . . . 3:14, 5:9
- Control room monitor metering . . . . . 6:4
- Control room monitor, glossary entry . . . . . 1:2
- Control Screens . . . . . 10:1, 10:11
- Copy . . . . . 10:2, 10:21
- Creating Text and Editing . . . . . 10:18
- Cue mix balance . . . . . 5:3
- Cue mix equaliser . . . . . 5:3
- Cue mix level . . . . . 5:3
- Cue Mix Panels . . . . . 3:17
- Cue mix system . . . . . 5:3 - 5:4
- Cue sends . . . . . 5:8
- Cue sends in follow monitor . . . . . 5:8
- Cue, glossary entry . . . . . 1:2
- Cue/reverb send outputs . . . . . 5:2
- Cut a group of large faders . . . . . 4:14
- Cut facilities . . . . . 3:7
- Cut facility . . . . . 4:14
- Cut individual circuits . . . . . 4:14
- Cut monitoring . . . . . 5:9
- Cut solo default status . . . . . 4:10
- Cut solo indication . . . . . 4:10
- Cut the studio monitor . . . . . 5:11
- Cut, glossary entry . . . . . 1:3
- Cut/boost . . . . . 7:9
  
- Delete . . . . . 10:2
- Delete Function . . . . . 10:15
- Diagnostics . . . . . 10:2, 10:14
- Diagnostics Mode . . . . . 9:18
- Dialog . . . . . 9:8
- Digital cal . . . . . 6:2
- Dim level . . . . . 5:9
- Dim monitoring . . . . . 5:9
- Direct input to fader . . . . . 8:1 - 8:2
- Direct routing . . . . . 4:2, 4:6
- Disk Commands . . . . . 10:12 - 10:13
- DS4 . . . . . 9:7

- Dump, glossary entry . . . . . 1:3
- Dynamic control . . . . . 3:3
- Dynamics . . . . . 7:1
  
- Echo return effects send, glossary entry . . . . . 1:3
- Effects return . . . . . 4:16
- Eight mono aux sends . . . . . 4:4
- Enable panning . . . . . 4:2
- Enable stereo aux pairs . . . . . 4:5
- EQ, glossary entry . . . . . 1:3
- Equaliser . . . . . 7:1, 7:8 - 7:9
- Equalisers . . . . . 3:5
- Expander . . . . . 7:3 - 7:4
- External gate/expander trigger . . . . . 7:3
- External key . . . . . 7:3
  
- Fader automation . . . . . 3:8
- Fader direct input module . . . . . 8:1 - 8:2
- Fader record . . . . . 3:8
- Fader swap . . . . . 4:8, 4:10
- Fader swap, global . . . . . 5:6
- Fader, glossary entry . . . . . 1:3
- Film Bus Modes . . . . . 9:2
- Filter slope . . . . . 7:2
- Filters, glossary entry . . . . . 1:3
- Filters, VSP . . . . . 9:7
- Flip the inputs locally . . . . . 4:3
- Foldback, glossary entry . . . . . 1:3
- Follow monitor . . . . . 6:3
- Formant spectrum equalisers . . . . . 3:5
- Format Floppy Disk . . . . . 10:12
- Frequency control ranges . . . . . 7:8
  
- Gain make up . . . . . 7:5
- Gain, glossary entry . . . . . 1:3
- Gate . . . . . 7:3 - 7:4
- Gate range . . . . . 7:4
- Gate/expander release time . . . . . 7:4
- Getting into Recall from Flying Faders . . . . . 10:16
- Getting Started . . . . . 10:16
- Global fader automation . . . . . 3:9
- Global master fader controls . . . . . 3:9
- Glossary . . . . . 1:1 - 1:6, 10:1 - 10:6
- Group Insert Selection, VSP . . . . . 9:15
- GUIDED TOUR OF RECALL . . . . . 10:15 - 10:22
  
- Headphone level . . . . . 5:12
- Hidden Access Commands . . . . . 10:11
- High band Q . . . . . 7:9
- High pass filter . . . . . 7:2
- HiQ . . . . . 7:9
- Hold . . . . . 10:20
- Hold Mode . . . . . 10:3
  
- HPF, glossary entry . . . . . 1:3
- Hysteresis . . . . . 7:3
  
- In-line monitoring . . . . . 3:12
- Input filter . . . . . 7:1 - 7:2
- Input filters . . . . . 3:3
- Input module, glossary entry . . . . . 1:3
- Input section . . . . . 4:3
- Input, direct to fader . . . . . 8:1 - 8:2
- Inputs . . . . . 3:2
- Insertion . . . . . 7:7
- Insertion in the monitor path . . . . . 7:7
- Insertion pre/post-equaliser and dynamics . . . . . 7:7
- Inserts . . . . . 3:5, 7:1
- Inserts, for Groups on VSP . . . . . 9:15
- Inserts, VSP . . . . . 9:7
- Installation . . . . . 10:7
- Interlocking solo . . . . . 4:12
- Introduction . . . . . 2:1 - 2:18, 10:7
- Invert . . . . . 7:3
  
- Jackfield, glossary entry . . . . . 1:3
  
- Key Functions . . . . . 10:9
- Keyboard . . . . . 10:3, 10:8
  
- Latching solo . . . . . 4:11
- Limiter . . . . . 7:5 - 7:6
- Limiter, glossary entry . . . . . 1:4
- Line trim control range . . . . . 4:3
- Link, glossary entry . . . . . 1:4
- Linked Controls and Switches . . . . . 9:16
- List Store . . . . . 10:3
- Loadspeaker system selection . . . . . 5:9
- Low band Q . . . . . 7:9
- Low pass filter . . . . . 7:2
- LPF, glossary entry . . . . . 1:4
  
- Master level for monitor speakers . . . . . 5:9
- Master mic/line changeover . . . . . 5:6
- Master Mode Select Panel . . . . . 3:12
- Master status locally reversed for  
  record and mixdown modes . . . . . 4:7
- Master status selection . . . . . 5:6 - 5:7
- Match and auto match . . . . . 3:8
- Meter bridge . . . . . 3:10 - 3:11
- Meter control keys . . . . . 3:19
- Meter the external source selected . . . . . 6:5
- Meter the mix output . . . . . 6:5
- Meter the multitrack return signal . . . . . 6:3
- Meter the multitrack send signal . . . . . 6:3
- Metering . . . . . 6:1 - 6:8
- Metering follows the multi-track  
  monitor selection . . . . . 6:3

- Metering type . . . . . 6:4
- Metering, VSP. . . . . 9:5
- Mic input range . . . . . 4:3
- Mic/line changeover switching. . . . . 4:3
- Mid band Q . . . . . 7:8
- Mix Bus Signal Flow . . . . . 9:3
- Mix outputs . . . . . 4:15
- Mixdown . . . . . 5:7
- Mixdown, introduction. . . . . 2:4
- Module, glossary entry . . . . . 1:4
- Momentary solo . . . . . 4:13
- Mon . . . . . 10:20
- Monitor and facilities . . . . . 3:12 - 3:20
- Monitor cut . . . . . 5:9
- Monitor Cut and Solo . . . . . 9:15
- Monitor dim . . . . . 5:9
- Monitor dim level . . . . . 5:9
- Monitor level of PFL/AFL signals . . . . . 5:9
- Monitor meters . . . . . 3:11
- Monitor path assignment . . . . . 4:9
- Monitor path selectors. . . . . 3:6
- Monitor path switching . . . . . 3:6
- Monitor Screen . . . . . 10:3
- Monitor Select and Talkback Panel . . . . . 3:14
- Monitor selection . . . . . 5:10
- Monitor Speaker Set. . . . . 9:9
- Monitor the auxiliaries, cues, and 2-track mix outputs . . . . . 5:10
- Monitoring. . . . . 5:1 - 5:14
- Mon-mix the monitoring. . . . . 5:9
- Mono aux sends . . . . . 4:4
- MONO Input/Output Routing . . . . . 9:14
- Multitrack meters . . . . . 3:10, 6:1 - 6:3
- Multitrack monitoring and overdubbing . . . . . 5:8
- Multitrack recording, introduction . . . . . 2:2
- Multitrack return . . . . . 5:8
- Multitrack routing matrix . . . . . 3:2
- Multitrack send . . . . . 5:8
- Muted gate level . . . . . 7:4
  
- Next chan, . . . . . 10:20
- Normalling, glossary entry . . . . . 1:4
- Null LEDs, glossary entry . . . . . 1:4
  
- OK Screen. . . . . 10:3
- Open Channel List . . . . . 10:17
- Open Store List . . . . . 10:19 - 10:22
- Option Information . . . . . 10:3
- Options, VSP feature . . . . . 9:6
- Oscillator and signal . . . . . 5:1
- Oscillator frequencies. . . . . 5:1
- Oscillator output level. . . . . 5:1
- Oscillator Override . . . . . 9:17
  
- Oscillator Panel . . . . . 3:15
- Oscillator, glossary entry . . . . . 1:4
- Output metering . . . . . 6:5
- Overdub . . . . . 5:8
- Overdubbing, introduction . . . . . 2:8
- Overload indicator . . . . . 6:2
  
- Paddle Switch . . . . . 9:16
- Pan the multitrack output . . . . . 4:2
- Pan, glossary entry . . . . . 1:4
- Panning mix output tracks . . . . . 4:15
- Parametric EQ, glossary entry . . . . . 1:4
- Patch free sub-grouping. . . . . 4:3
- Peak and shelving . . . . . 7:9
- PFL solo . . . . . 4:11
- PFL, glossary entry . . . . . 1:4
- Phantom power. . . . . 4:4
- Phantom power, glossary entry . . . . . 1:4
- Phase meter. . . . . 3:11, 6:7 - 6:8
- Phase reverse . . . . . 4:3
- Place the aux pre-fader . . . . . 4:4
- Playback Control . . . . . 9:6
- Post, glossary entry . . . . . 1:5
- PPM bright up point. . . . . 6:2
- PPM metering. . . . . 6:2
- Pre, glossary entry . . . . . 1:5
- Prepare Floppy disk for Recall Backup. . . . . 10:13
- Processing, dynamics and EQ . . . . . 7:1 - 7:10
- Programme dependent release time . . . . . 7:6
- Project . . . . . 10:17
- PSU Status LEDs . . . . . 3:11
  
- Q . . . . . 7:8
- Q varies with gain . . . . . 7:8
- Q, glossary entry . . . . . 1:5
- Quad ganging . . . . . 7:5
  
- RECALL . . . . . 10:1 - 10:14
- Recall Timeout. . . . . 10:3
- Record Active Flag. . . . . 10:3
- Red light . . . . . 5:13
- Release time . . . . . 7:4, 7:6
- Reset Cancelled Screen . . . . . 10:4
- Reset Flag . . . . . 10:4
- Reset the whole console for a function . . . . . 5:6
- Restore Floppy disk to hard disk . . . . . 10:13
- Return Talkback. . . . . 9:9
- Return, glossary entry . . . . . 1:5
- Rev return balance . . . . . 5:5
- Rev return equaliser. . . . . 5:5
- Rev return level . . . . . 5:5
- Rev Return Panels . . . . . 3:18
- Rev returns . . . . . 5:5

- Reverberation in the cue mixes . . . . . 5:5
- Reverse the selected master status . . . . . 5:6
- Reverse, glossary entry . . . . . 1:5
- Route back to the associated multitrack send. . . 4:2
- Route tracks 1 to 24. . . . . 4:1
- Route tracks 25 to 48 . . . . . 4:1
- Routing . . . . . 4:1 - 4:16
  
- Screens . . . . . 10:11
- Sections . . . . . 10:19
- Select auxiliaries in pairs to the monitor path. . 4:5
- Select the bounced down track . . . . . 4:2
- Select Title . . . . . 10:17
- Select up to eight mono aux sends. . . . . 4:4
- Selected Channels Only . . . . . 10:22
- Selective Store . . . . . 10:19
- Send, glossary entry. . . . . 1:5
- Set-up Procedure. . . . . 10:14
- Show Floppy Disk Contents . . . . . 10:12
- Sidechain equalising. . . . . 7:10
- SIG LED . . . . . 6:2
- Signal LED threshold . . . . . 3:15, 6:2
- Signal level of the multitrack send . . . . . 4:6
- Signal presence. . . . . 6:2
- Skip . . . . . 10:4
- Slate, glossary entry. . . . . 1:5
- Software Hard Reset . . . . . 9:18
- Solo a channel or monitor path  
in interlocking mode . . . . . 4:12
- Solo a channel or monitor path  
in latching mode . . . . . 4:12
- Solo a channel or monitor path  
in momentary mode . . . . . 4:13
- Solo a group of paths in interlocking mode. . 4:12
- Solo a group of paths in momentary mode. . 4:13
- Solo and cut facilities . . . . . 3:7
- Solo and master cut system . . . . . 4:10 - 4:14
- Solo level . . . . . 5:10
- Solo link. . . . . 4:11
- Solo safe mode . . . . . 4:11
- Solo system . . . . . 3:13
- Solo, glossary entry . . . . . 1:5
- Speaker Busses . . . . . 9:4
- Speaker Trims . . . . . 9:9
- Split monitoring . . . . . 3:12
- Status Flag . . . . . 10:4
- Stereo aux pairing . . . . . 5:2
- Stereo pair aux sends . . . . . 4:4
- Stereo pair linking . . . . . 7:5
- Store . . . . . 10:5
- Studio Loudspeakers with VSP . . . . . 9:10
- Studio monitor. . . . . 5:11
- Studio monitor follows the  
control room monitor. . . . . 5:11
  
- Studio warning light . . . . . 5:13
- Subgroup, glossary entry . . . . . 1:6
- Surround sound monitoring . . . . . 9:1
- Swap faders globally . . . . . 4:8
- Swap faders locally . . . . . 4:8
- Swap small and large faders . . . . . 4:8
- Switch effects returns via the monitor  
path to 2-track outputs. . . . . 4:1
- Switch stereo aux pairs on. . . . . 4:5
- Switch the oscillator signal onto the  
console group outputs . . . . . 5:1
- Switch the oscillator signal onto the  
main 4-track outputs. . . . . 5:1
- System information. . . . . 2:1 - 2:18
  
- Talkback . . . . . 3:14
- Talkback level . . . . . 5:13
- Talkback system . . . . . 5:12 - 5:14
- Talkback, glossary entry. . . . . 1:6
- Tape, glossary entry. . . . . 1:6
- Text Screens . . . . . 10:5, 10:11
- Threshold. . . . . 7:4
- Threshold level . . . . . 7:5
- Threshold range . . . . . 7:5
- Title . . . . . 10:5, 10:16
- Title Structure and Editing. . . . . 10:17
- To Access the Text Column . . . . . 10:18
- To Access Title Header from the  
Top Level Menu. . . . . 10:16
- To create a new title . . . . . 10:16
- To create new Client or Project Headers. . . 10:17
- To Edit Existing Text . . . . . 10:18
- To Fill in Channel List. . . . . 10:17
- To Fill in Title Header. . . . . 10:16
- To Make a Store . . . . . 10:19
- To open a List . . . . . 10:21
- To Recall a Store . . . . . 10:20
- To select a Store . . . . . 10:21
- To select a Title. . . . . 10:21
- To View Existing Text . . . . . 10:18
- Top Level Menu . . . . . 10:16 - 10:18
- Track bounce . . . . . 4:2
- Track bouncing, introduction . . . . . 2:6
- Track level control . . . . . 3:6
- Trim, glossary entry . . . . . 1:6
  
- Use panning . . . . . 4:2
- Use the I/O module as an effects return . . . 4:16
  
- View Channel List . . . . . 10:5
- View Screens . . . . . 10:5
- VSP . . . . . 9:1 - 9:18
- VU metering . . . . . 6:1
- VU metering sensitivity . . . . . 6:1

- VU meters, dynamic . . . . . 3:19
- Warning light . . . . . 5:13
- Width, glossary entry . . . . . 1:6
  
- Zoom . . . . . 10:5
- Zoom Keys . . . . . 10:6
- Zoom Screens . . . . . 10:6
- Zooms . . . . . 10:20